

Jasper II

KING[®]
L I V I N G



kingliving.com

Jasper II Components

Platforms

D1040 (41") H240 (9.5")

P78



780 (30.75")

P104



1040 (41")

P130

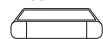

1300 (51.25")

P156

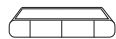

1560 (61.25")

P182

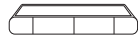

1820 (71.75")

P208



2080 (82")

P234



2340 (92.25")

P260



2600 (102.25")

Platforms Deep

D1300 (51.25") H240 (9.5")

P104D



1040 (41")

P130D

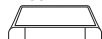

1300 (51.25")

P182D



1820 (71.75")

P208D



2080 (82")

P234D

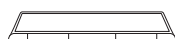

2340 (92.25")

P130 CORNER

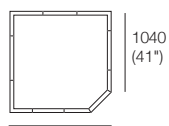

1300 (51.25")

Seat Cushions

D1040 (41") H200 (7.75")

C104D



1040 (41")

C156D

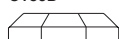

1560 (61.5")

C182D

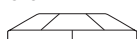

1820 (71.75")

C208D

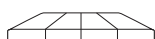

2080 (82")

C104 78 CORNER

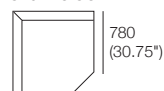

1040 (41")

S Ottoman Platform

D780 (30.75") H240 (9.5")

S Ottoman 104-D78



1040 (41")

Seat Cushions

D780 (30.75") H200 (7.75")

C78



780 (30.75")

C91



910 (35.75")

C104



1040 (41")

C156

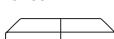

1560 (61.5")

C182

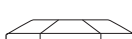

1820 (71.75")

C208

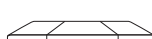

2080 (82")

Storage Bases

D1040 (41") H240 (9.5")

S Base 182 S156 RH

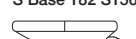

1820 (71.75")

S Base 182 S156 LH

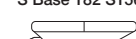

1820 (71.75")

S Base 234 S208 RH

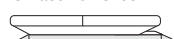

2340 (92.25")

S Base 234 S208 LH

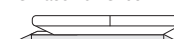

2340 (92.25")

S Base 182 S78 RH



1820 (71.75")

S Base 182 S78 LH



1820 (71.75")

Storage Bases Deep

D1300 (51.25") H240 (9.5")

S Base 208D S104 RH



2080 (82")

S Base 208D S104 LH



2080 (82")

Components & Accessories

Arms / Backs

W260 (10.25") H310 (12.25")

A78



A78 SMART



A104



A104 SMART



A130

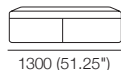

A130 SMART

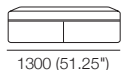

A156

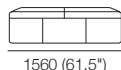

A156 SMART



A182

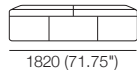

A182 SMART

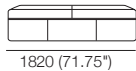

A208

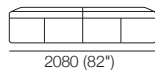

A208 SMART

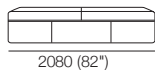

Timber Veneer Shelves

W260 (10.25") H310 (12.25")

T78 Timber Veneer T78 Charge



T104 Timber Veneer T104 Charge

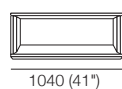

T208 Timber Veneer

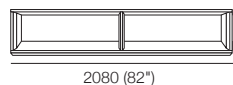

Back Cushions

Front View

H500 (19.75")

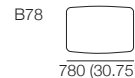

Leather Back Cushions

Back View Detail: Bolster
Stitching / Tricot / Perforation

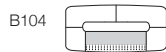

Media Console

MC52

D1040 (41")

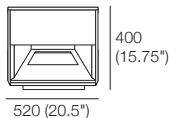

MC38

D1040 (41")

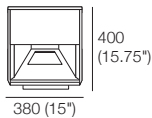

Sonos SPEAKER Bracket

Stainless Steel / Black

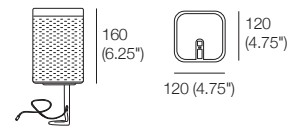

RND CHARGE TrayTable

Timber Veneer

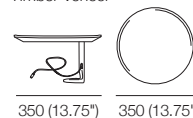

Tray CARRARA 350

Carrara Marble

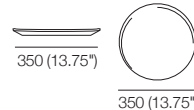

Tray Timber 350

Timber Veneer

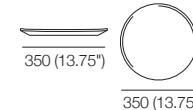

Sofa Light 1214

Timber Veneer

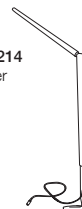

RND TrayTable CARRARA

Carrara Marble

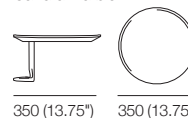

RND TrayTable

Timber Veneer

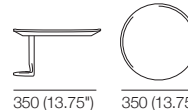

Bed Brackets





DT201 8567 V5

Effective March 2019. Use Magic Joiner M115. Timber Veneer Shelves, Tables, Trays and Sofa Light available in King Living timber finishes. Back Cushions sold separately – price extra. As King Living has a policy of continuous improvement, changes to products and specifications may be made without prior notice. Images and drawings are representative of design only. Accessories not included.

Jasper II Packages

KING[®]
L I V I N G



kingliving.com

Jasper II Packages

1AB + 1AB SMART*

1x P234, 1x P208D, 2x C104,
1x C182D, 1x A208, 2x A104, 4x B104
Shelf Options*: Standard or Charge
2x T104 (*Shelves not included)

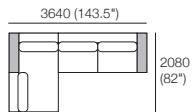

7B + 7B SMART*

1x P208, 1x P182, 1x P234, 1x C182, 1x C156,
2x C104, 3x A104, 1x A78, 1x A208, 2x B104,
3x B78. Shelf Options*: Standard or Charge
1x T104, 2x T78 (*Shelves not included)

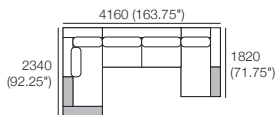

9B + 9B SMART*

1x P234, 1x P208, 2x C104,
1x C182, 2x A104, 1x A208, 3x B104,
1x B78. Shelf Options*: Standard or Charge
1x T104, 1x T78 (*Shelves not included)

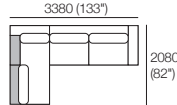

13B + 13B SMART*

2x P182, 2x C156, 1x A156,
1x A104, 1x A78, 4x B78
Shelf Options: Standard or Charge
1x T104, 1x T78 (*Shelves not included)

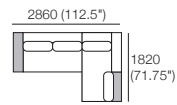

13BU + 13BU SMART*

2x P182, 2x C156, 1x A156,
2x A104, 2x A78, 4x B78

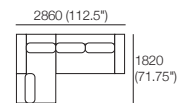

1AB SRH + 1AB SRH SMART*

1x SBase 208D S104 RH,
1x SBase 234 S208 LH,
1x A208, 2x A104, 4x B104
Shelf Options*: Standard or Charge
2x T104 (*Shelves not included)

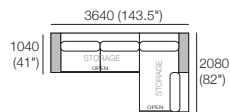

7B SLH182 + 7B SLH182 SMART*

1x SBase 182 S78 LH, 1x P234,
1x P208, 1x C182, 2x C104, 1x A208,
3x A104, 1x A78, 2x B104, 3x B78
Shelf Options*: Standard or Charge
1x T104, 2x T78 (*Shelves not included)

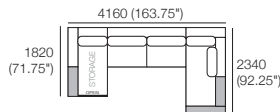

9B SLH S234 + 9B SLH S234 SMART*

1x S Base 234 S208 RH, 1x P208,
1x C182, 1x A208, 2x A104, 3x B104,
1x B78. Shelf Options*: Standard or Charge
1x T104, 1x T78 (*Shelves not included)

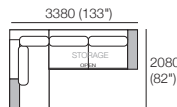

13B SLH + 13B SLH SMART*

1x SBase 182 S156 RH,
1x SBase 182 S78 LH,
1x A156, 1x A104, 1x A78, 4x B78
Shelf Options*: Standard or Charge
1x T104, 1x T78 (*Shelves not included)

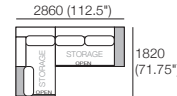

13BU SLH + 13BU SLH SMART*

1x SBase 182 S156 RH,
1x SBase 182 S78 LH,
1x A156, 2x A104, 2x A78, 4x B78

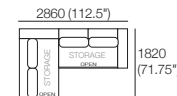

1AB SLH + AB SLH SMART*

1x SBase 208D S104 LH,
1x SBase 234 S208 RH,
1x A208, 2x A104, 4x B104
Shelf Options*: Standard or Charge
2x T104 (*Shelves not included)

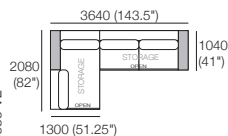

7B SRH182 + 7B SRH182 SMART*

1x SBase 182 S78 RH, 1x P234,
1x P208, 1x C182, 2x C104, 1x A208,
3x A104, 1x A78, 2x B104, 3x B78
Shelf Options*: Standard or Charge
1x T104, 2x T78 (*Shelves not included)

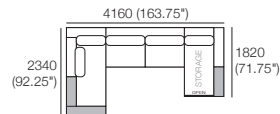

9B SRH S234 + 9B SRH S234 SMART*

1x S Base 234 C208 LH, 1x P208, 1x C182,
1x A208, 2x A104, 3x B104, 1x B78
Shelf Options*: Standard or Charge
1x T104, 1x T78 (*Shelves not included)

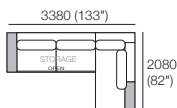

13B SRH + 13B SRH SMART*

1x SBase 182 S156 LH,
1x SBase 182 S78 RH,
1x A156, 1x A104, 1x A78, 4x B78
Shelf Options*: Standard or Charge
1x T104, 1x T78 (*Shelves not included)

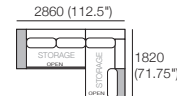

13BU SRH + 13BU SRH SMART*

1x SBase 182 S156 LH,
1x SBase 182 S78 RH,
1x A156, 2x A104, 2x A78, 4x B78

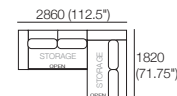

Jasper II Packages 1AB

KING[®]
L I V I N G



kingliving.com

Jasper II Packages 1AB

Package: 1AB

Components: 1x P234, 1x P208D, 2x C104,
1x C182D, 1x A208, 2x A104, 4x B104

Shelf Options*: Standard or Charge

2x T104 (*Shelves not included – price extra)

Configurations:

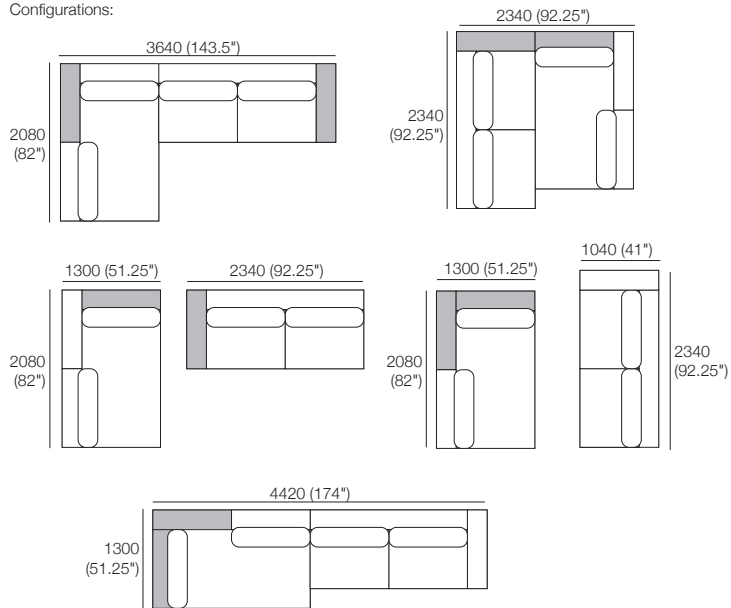

Package: 1AB SMART

Components: 1x P234, 1x P208D, 2x C104,
1x C182D, 1x A208 SMART, 2x A104 SMART, 4x B104

Shelf Options*: Standard or Charge

2x T104 (*Shelves not included – price extra)

Configurations:

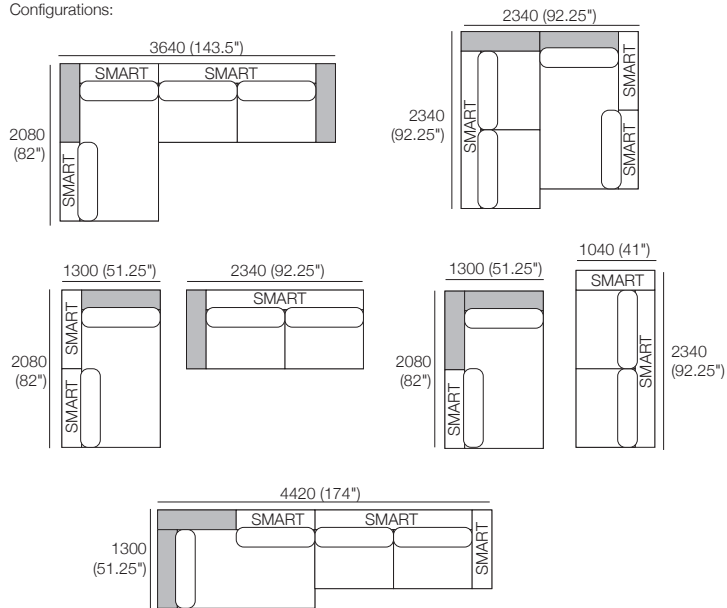

Jasper II Packages 1AB

Package: 1AB SLH

Components: 1x SBase 208D S104 LH, 1x SBase 234 S208 RH,
1x A208, 2x A104, 4x B104

Shelf Options*: Standard or Charge

2x T104 (*Shelves not included – price extra)

Configurations:

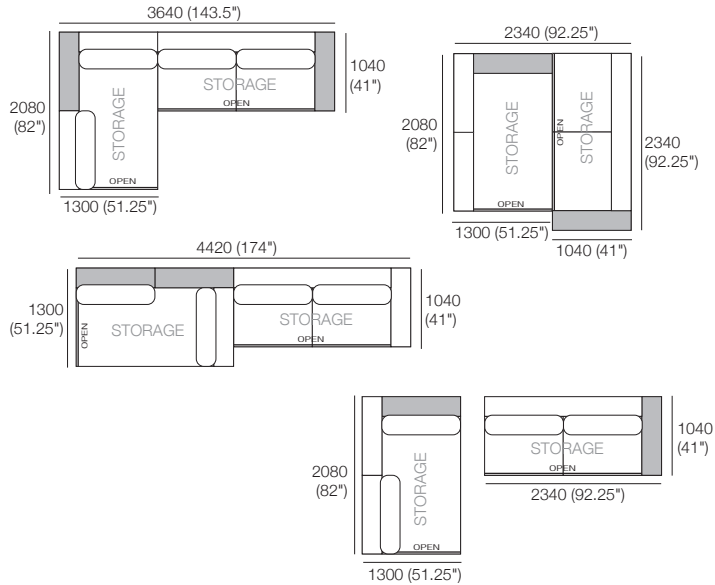

Package: 1AB SLH SMART

Components: 1x SBase 208D S104 LH, 1x SBase 234 S208 RH,
1x A208 SMART, 2x A104 SMART, 4x B104

Shelf Options*: Standard or Charge

2x T104 (*Shelves not included – price extra)

Configurations:

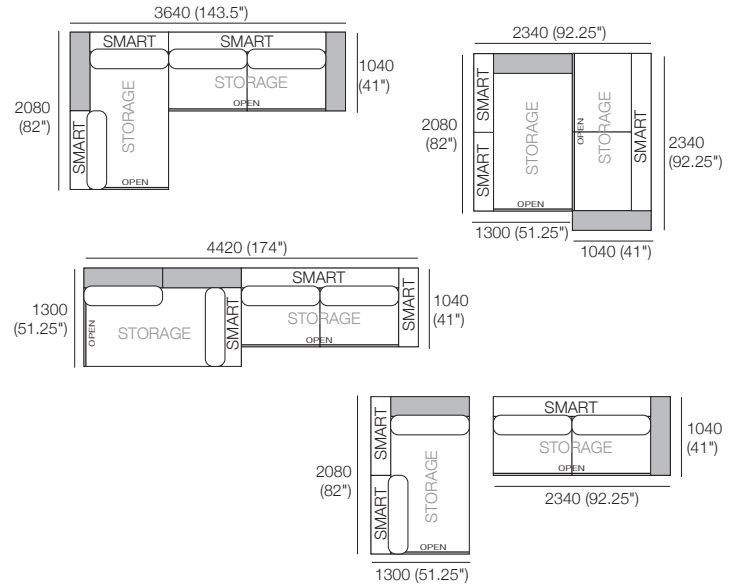

Jasper II Packages 1AB

Package: 1AB SRH

Components: 1x SBase 208D S104 RH, 1x SBase 234 S208 LH, 1x A208,

2x A104, 4x B104

Shelf Options*: Standard or Charge

2x T104 (*Shelves not included – price extra)

Configurations:

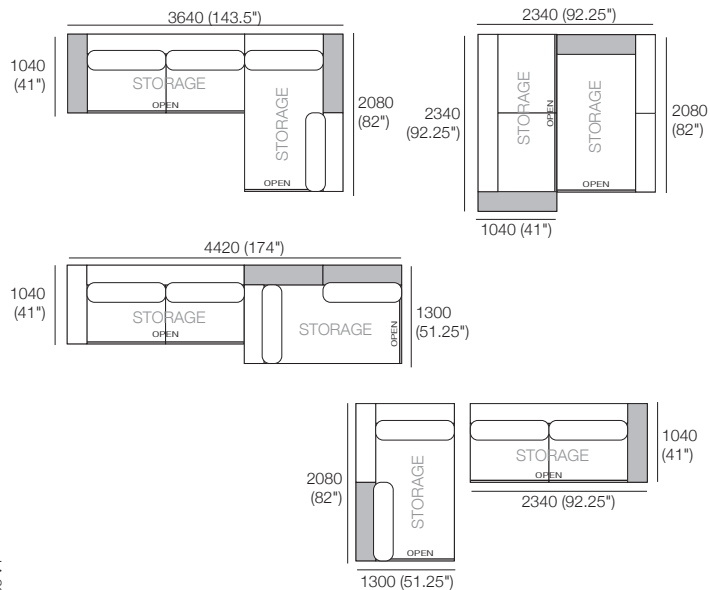

Package: 1AB SRH SMART

Components: 1x SBase 208D S104 RH, 1x SBase 234 S208 LH, 1x A208 SMART,

2x A104 SMART, 4x B104

Shelf Options*: Standard or Charge

2x T104 (*Shelves not included – price extra)

Configurations:

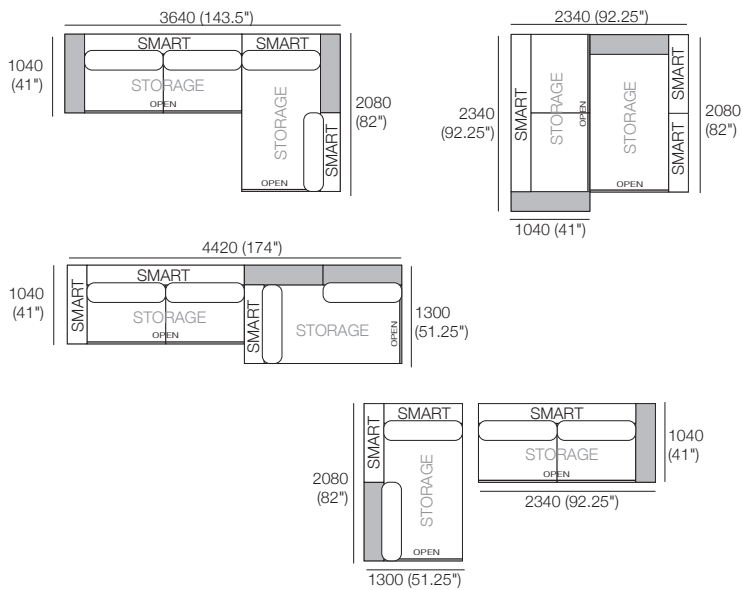

Jasper II Packages 7B

KING[®]
L I V I N G



kingliving.com

Jasper II Packages 7B

Packages: 7B + 7B SMART* (*SMART Arms replace STD Arms)

Components: 1x P208, 1x P182, 1x P234, 1x C182, 1x C156, 2x C104,

3x A104, 1x A78, 1x A208, 2x B104, 3x B78

Shelf Options*: Standard or Charge

1x T104, 2x T78 (*Shelves not included – price extra)

Configurations:

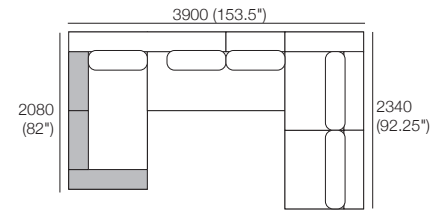
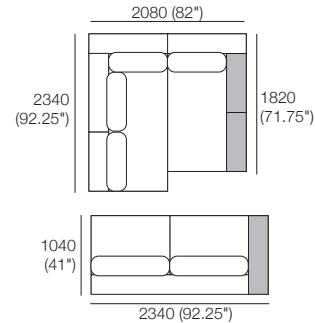
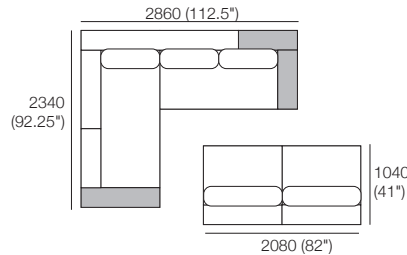
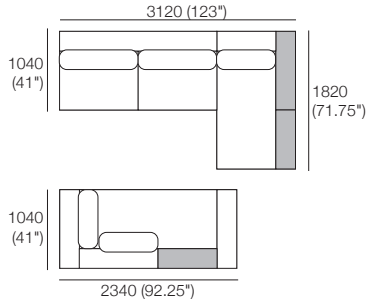
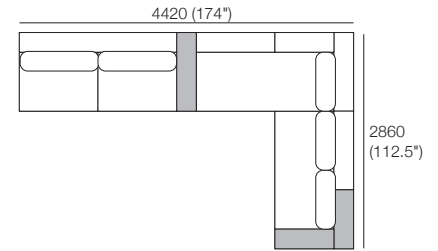
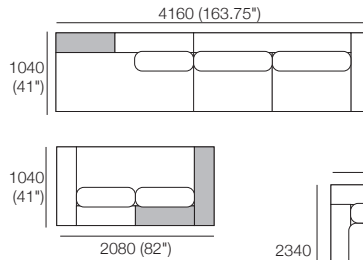
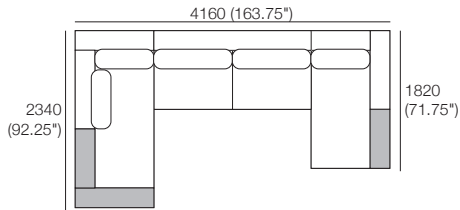

Effective November 2018. Use Magic Joiner M115. *Shelf Options: Standard or Charge (not included in package – price extra) available in King Living timber finishes. *SMART Packages: SMART Arms replace STD Arms. As King Living has a policy of continuous improvement, changes to products and specifications may be made without prior notice. Images and drawings are representative of design only. Accessories not included.

Jasper II Packages 7B

Packages: 7B SLH182 + 7B SLH182 SMART* (*SMART Arms replace STD Arms)

Components: 1x SBase 182 S78 LH, 1x P234, 1x P208, 1x C182, 2x C104,

1x A208, 3x A104, 1x A78, 2x B104, 3x B78

Shelf Options*: Standard or Charge

1x T104, 2x T78 (*Shelves not included – price extra)

Configurations:

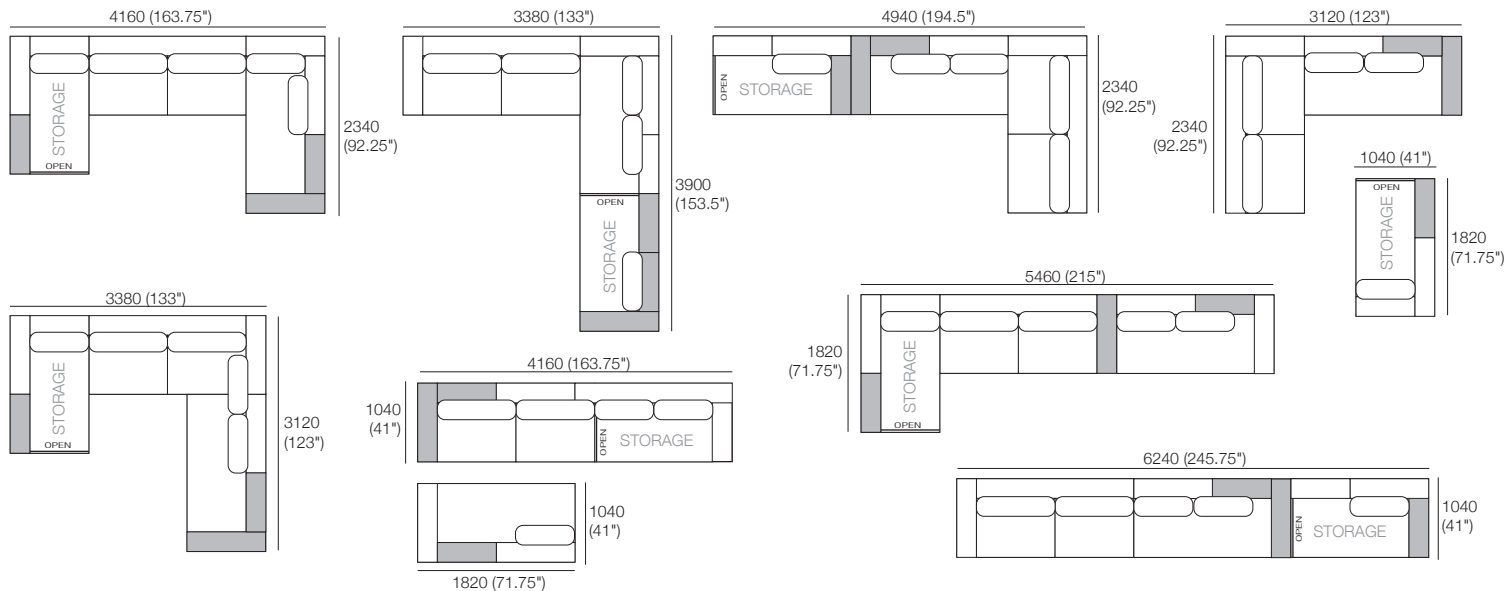

Effective November 2018. Use Magic Joiner M115. *Shelf Options: Standard or Charge (not included in package – price extra) available in King Living timber finishes. *SMART Packages: SMART Arms replace STD Arms. As King Living has a policy of continuous improvement, changes to products and specifications may be made without prior notice. Images and drawings are representative of design only. Accessories not included.

Jasper II Packages 7B

Packages: 7B SRH182 + 7B SRH182 SMART* (*SMART Arms replace STD Arms)

Components: 1x SBase 182 S78 RH, 1x P234, 1x P208, 1x C182, 2x C104,
1x A208, 3x A104, 1x A78, 2x B104, 3x B78

Shelf Options*: Standard or Charge

1x T104, 2x T78 (*Shelves not included – price extra)

Configurations:

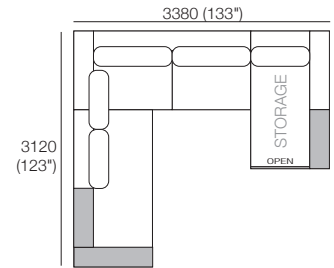
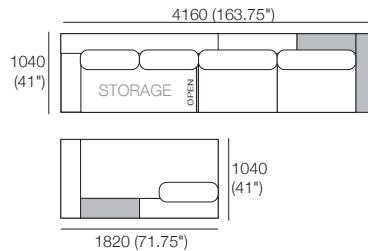
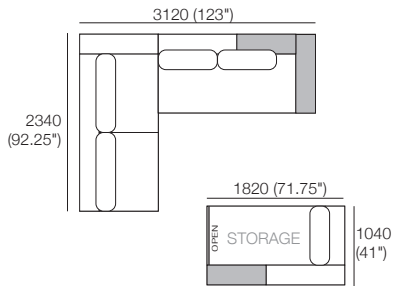
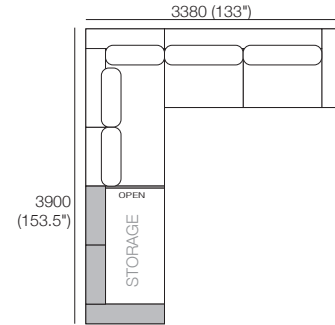
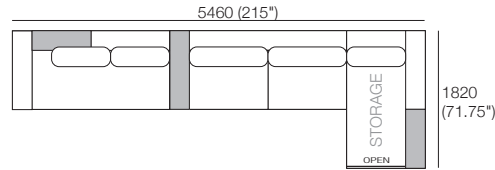
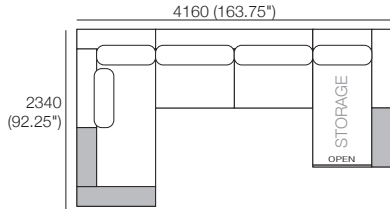

Jasper II Packages 13B

KING[®]
L I V I N G



kingliving.com

Jasper II Packages 13B

Package: 13B

Components: 2x P182, 2x C156,
1x A156, 1x A104, 1x A78, 4x B78
Shelf Options*: Standard or Charge
1x T104, 1x T78 (*Shelves not included – price extra)
Configurations:

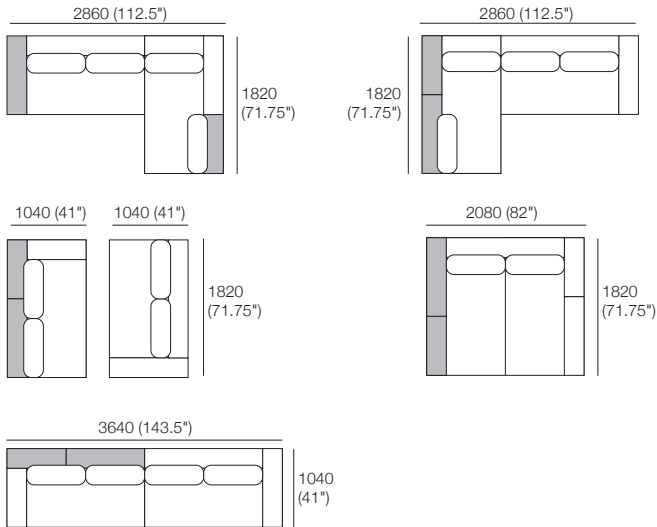

Package: 13B SMART

Components: 2x P182, 2x C156, 1x A156 SMART,
1x A104 SMART, 1x A78 SMART, 4x B78
Shelf Options*: Standard or Charge
1x T104, 1x T78 (*Shelves not included – price extra)
Configurations:

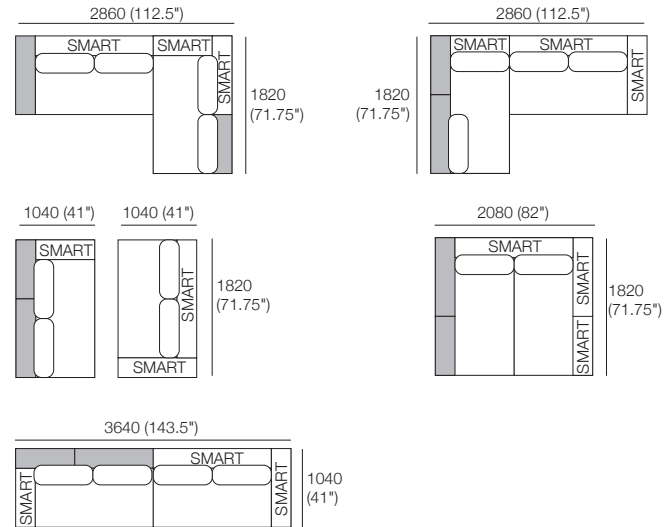

Jasper II Packages 13B

Package: 13B SLH

Components: 1x SBase 182 S156 RH, 1x SBase 182 S78 LH,
 1x A156, 1x A104, 1x A78, 4x B78
 Shelf Options*: Standard or Charge
 1x T104, 1x T78 (*Shelves not included – price extra)
 Configurations:

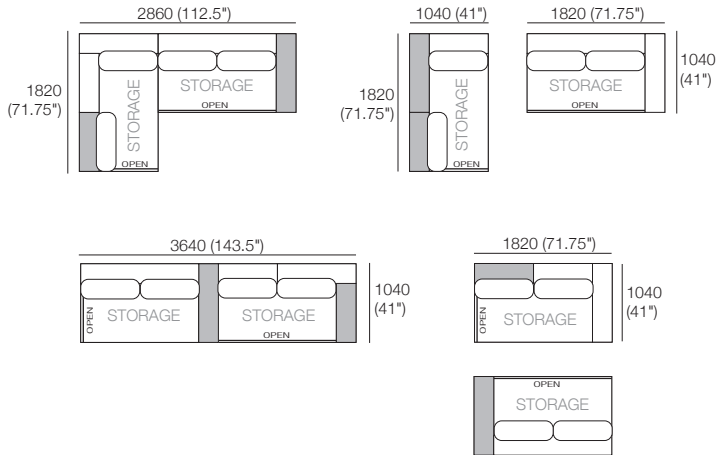

Package: 13B SLH SMART

Components: 1x SBase 182 S156 RH, 1x SBase 182 S78 LH,
 1x A156 SMART, 1x A104 SMART, 1x A78 SMART, 4x B78
 Shelf Options*: Standard or Charge
 1x T104, 1x T78 (*Shelves not included – price extra)
 Configurations:

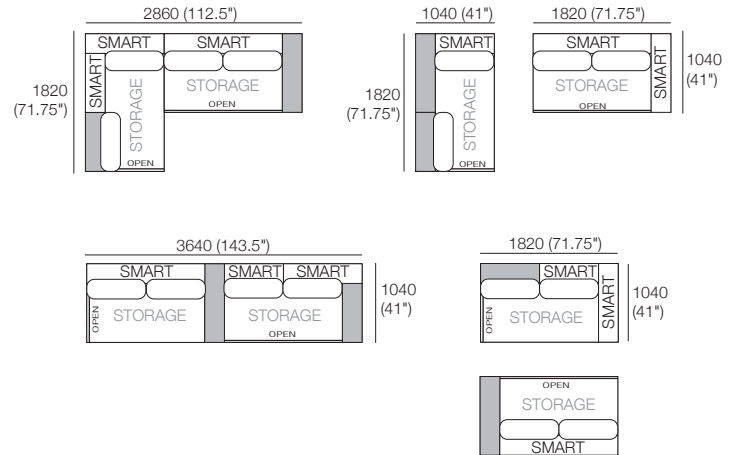

Jasper II Packages 13B

Package: 13B SRH

Components: 1x SBase 182 S156 LH, 1x SBase 182 S78 RH,
 1x A156, 1x A104, 1x A78, 4x B78
 Shelf Options*: Standard or Charge
 1x T104, 1x T78 (*Shelves not included – price extra)
 Configurations:

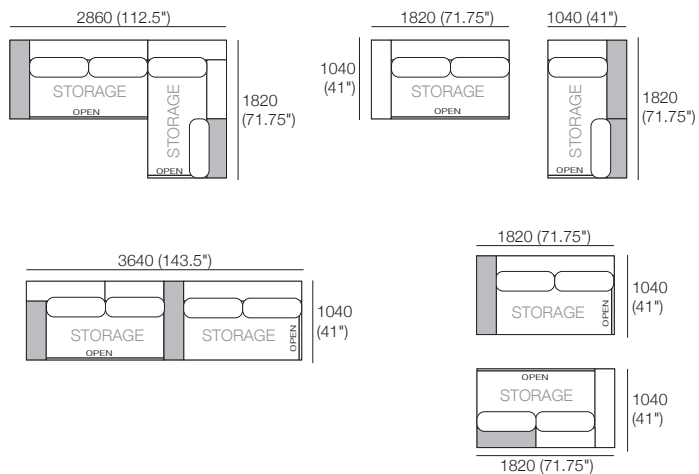

Package: 13B SRH SMART

Components: 1x SBase 182 S156 LH, 1x SBase 182 S78 RH, 1x A156 SMART,
 1x A104 SMART, 1x A78 SMART, 4x B78
 Shelf Options*: Standard or Charge
 1x T104, 1x T78 (*Shelves not included – price extra)
 Configurations:

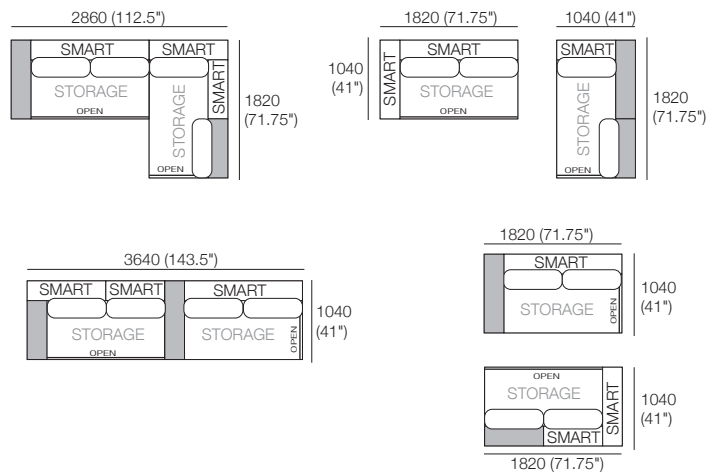

Jasper II Packages 13BU

KING[®]
L I V I N G



kingliving.com

Jasper II Packages 13BU

Package: 13BU

Components: 2x P182, 2x C156, 1x A156,
2x A104, 2x A78, 4x B78

Configurations:

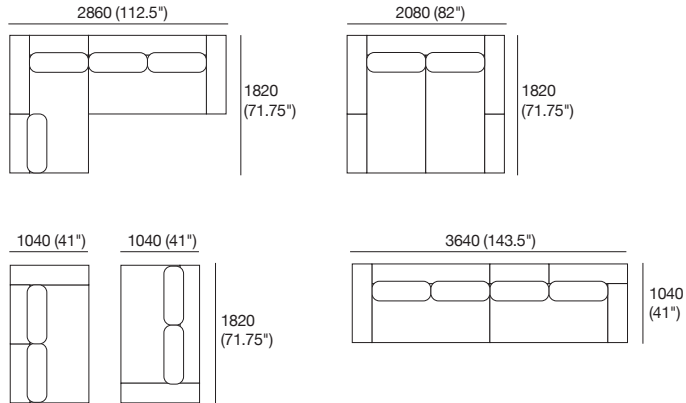

Package: 13BU SMART

Components: 2x P182, 2x C156, 1x A156 SMART,
2x A104 SMART, 2x A78 SMART, 4x B78

Configurations:

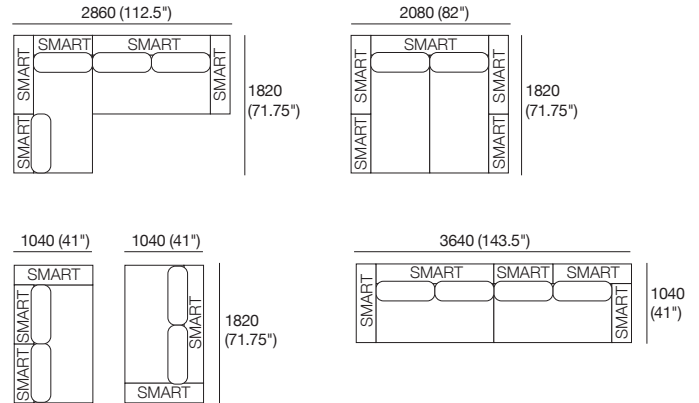

Jasper II Packages 13BU

Package: 13BU SLH

Components: 1x SBase 182 S156 RH, 1x SBase 182 S78 LH,
1x A156, 2x A104, 2x A78, 4x B78

Configurations:

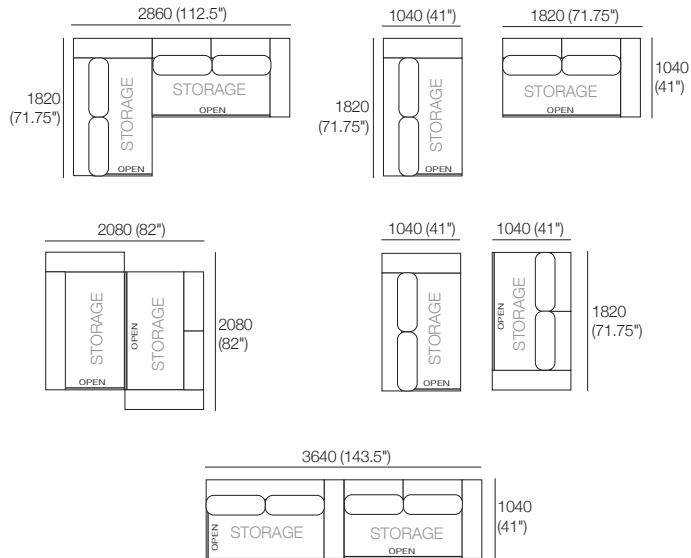

Package: 13BU SLH SMART

Components: 1x SBase 182 S156 RH, 1x SBase 182 S78 LH, 1x A156 SMART,
2x A104 SMART, 2x A78 SMART, 4x B78

Configurations:

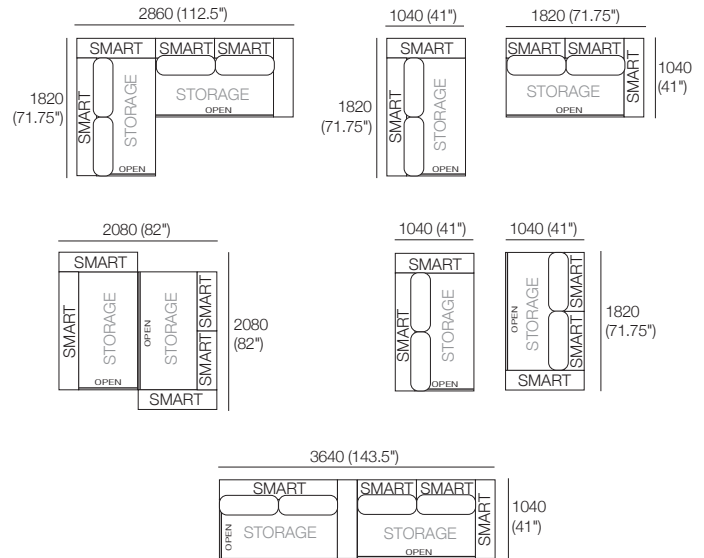

Jasper II Packages 13BU

Package: 13BU SRH

Components: 1x SBase 182 S156 LH, 1x SBase 182 S78 RH,
1x A156, 2x A104, 2x A78, 4x B78
Configurations:

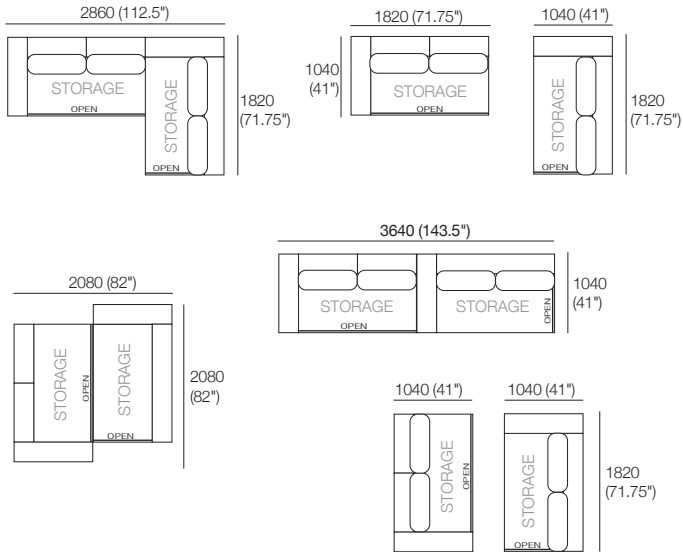

Package: 13BU SRH SMART

Components: 1x SBase 182 S156 LH, 1x SBase 182 S78 RH, 1x A156 SMART,
2x A104 SMART, 2x A78 SMART, 4x B78
Configurations:

