

Jasper II

KING[®]
L I V I N G



kingliving.com

Jasper II Components

Platforms

D1040 (41") H240 (9.5")

P78



780 (30.75")

P104



1040 (41")

P130



1300 (51.25")

P156

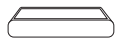

1560 (61.25")

P182

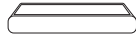

1820 (71.75")

P208



2080 (82")

P234



2340 (92.25")

P260



2600 (102.25")

Platforms Deep

D1300 (51.25") H240 (9.5")

P104D



1040 (41")

P130D



1300 (51.25")

P182D



1820 (71.75")

P208D



2080 (82")

P234D



2340 (92.25")

P130 CORNER

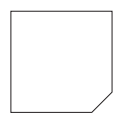

1040 (41")

1300 (51.25")

Seat Cushions

D1040 (41") H200 (7.75")

C104D



1040 (41")

C156D

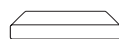

1560 (61.5")

C182D

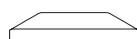

1820 (71.75")

C182R

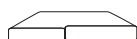

1820 (71.75")

C104 78 CORNER

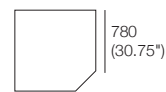

780 (30.75")

1040 (41")

S Ottoman Platform

D780 (30.75") H240 (9.5")

S Ottoman 104-D78



1040 (41")

Seat Cushions

D780 (30.75") H200 (7.75")

C78



780 (30.75")

C91



910 (35.75")

C104



1040 (41")

C156

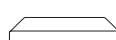

1560 (61.5")

C182

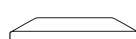

1820 (71.75")

C208

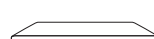

2080 (82")

Storage Bases

D1040 (41") H240 (9.5")

S Base 182 S156 RH

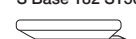

1820 (71.75")

S Base 182 S156 LH

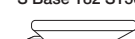

1820 (71.75")

S Base 234 S208 RH



2340 (92.25")

S Base 234 S208 LH



2340 (92.25")

S Base 182 S78 RH



1820 (71.75")

S Base 182 S78 LH



1820 (71.75")

Storage Bases Deep

D1300 (51.25") H240 (9.5")

S Base 208D S104 RH



2080 (82")

S Base 208D S104 LH



2080 (82")

Components & Accessories

Arms / Backs

W260 (10.25") H310 (12.25")

A78



780 (30.75")

A78 SMART



780 (30.75")

A104



1040 (41")

A104 SMART



1040 (41")

A130



1300 (51.25")

A130 SMART



1300 (51.25")

A156



1560 (61.5")

A156 SMART



1560 (61.5")

A182



1820 (71.75")

A182 SMART



1820 (71.75")

A208



2080 (82")

A208 SMART



2080 (82")

Timber Veneer Shelves

W260 (10.25") H310 (12.25")

T78 Timber Veneer
T78 Charge



780 (30.75")

T104 Timber Veneer
T104 Charge

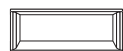

1040 (41")

T208 Timber Veneer

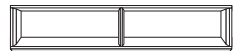

2080 (82")

Back Cushions

H500 (19.75")

B78
(Small)



780 (30.75")

B91
(Medium)



910 (36")

B104
(Large)



1040 (41")

Media Console

MC52

D1040 (41")



400
(15.75")

520 (20.5")



Back

MC38

D1040 (41")



400
(15.75")

380 (15")



Back

Sofa Light 1214

Timber Veneer



Bed Brackets



Sonos SPEAKER Bracket

Stainless Steel / Black



160
(6.25")



120
(4.75")

120 (4.75")

RND CHARGE TrayTable

Timber Veneer



350 (13.75")



350 (13.75")

RND TrayTable

Timber Veneer



350 (13.75")



350 (13.75")

RND TrayTable CARRARA

Carrara Marble



350 (13.75")



350 (13.75")

Tray Timber 350

Timber Veneer



350 (13.75")



350 (13.75")

Tray CARRARA 350

Carrara Marble



350 (13.75")



350 (13.75")

REC Table 104

Timber Veneer

W260 (10.25")



1040 (41")

REC Table 78

Timber Veneer

W260 (10.25")

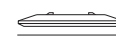

780 (30.75")



DT201 8567 V4

Effective September 2018. Use Magic Joiner M115. Timber Veneer Shelves, Tables, Trays and Sofa Light available in King Living timber finishes. Back Cushions sold separately – price extra. As King Living has a policy of continuous improvement, changes to products and specifications may be made without prior notice. Images and drawings are representative of design only. Accessories not included.

Jasper II Package Chairs



Package: Chair 104T

Components: 1x Platform P104, 1x Seat Cushion C78,
1x Arm A78, 1x Back Cushion B78

Shelf Options:

Timber Veneer (STD): 1x T104

Timber Veneer (Charge): 1x T104 Charge

Configurations:

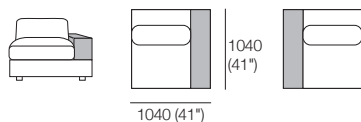

Package: Chair 104T SMART

Components: 1x Platform P104, 1x Seat Cushion C78,
1x Arm A78 SMART, 1x Back Cushion B78

Shelf Options:

Timber Veneer (STD): 1x T104

Timber Veneer (Charge): 1x T104 Charge

Configurations:

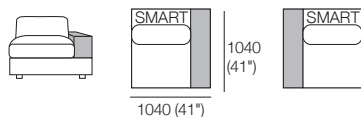

Package: Chair 130T

Components: 1x Platform P130, 1x Seat Cushion C104,
1x Arm A104, 1x Back Cushion B104

Shelf Options:

Timber Veneer (STD): 1x T104

Timber Veneer (Charge): 1x T104 Charge

Configurations:

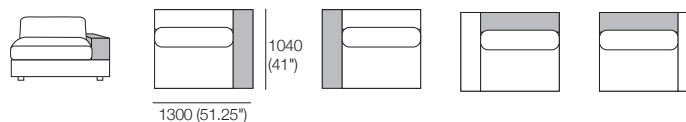

Package: Chair 130T SMART

Components: 1x Platform P130, 1x Seat Cushion C104,
1x Arm A104 SMART, 1x Back Cushion B104

Shelf Options:

Timber Veneer (STD): 1x T104

Timber Veneer (Charge): 1x T104 Charge

Configurations:

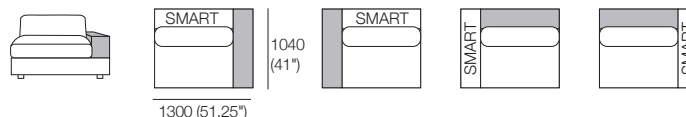

DT2018612 V1

Effective September 2018. Use Magic Joiner M115. *Shelf options not included in package – price extra. Timber Veneer Shelves available in King Living timber finishes.

As King Living has a policy of continuous improvement, changes to products and specifications may be made without prior notice. Images and drawings are representative of design only. Accessories not included.

kingliving.com

Jasper II Packages

KING[®]
L I V I N G



kingliving.com

Jasper II Packages

Packages: 13 + 13 SMART

2x P182, 2x C156, 1x A104,
1x A156, 1x A78, 3x B78

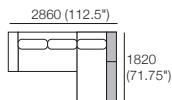

Packages: 13 SLH + 13 SLH SMART

1x S Base 182 S156 RH, 1x S Base 182 S78 LH,
1x A104, 1x A156, 1x A78, 3x B78

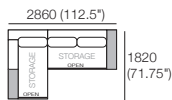

Packages: 13 SRH + 13 SRH SMART

1x S Base 182 S156 LH, 1x S Base 182 S78 RH,
1x A104, 1x A156, 1x A78, 3x B78

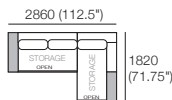

Packages: 1A + 1A SMART

1x P234, 1x P208D, 2x C104,
1x C182D, 1x A208, 2x A104, 3x B104

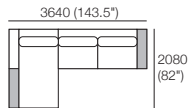

Packages: 13U + 13U SMART

2x P182, 2x C156, 2x A104,
1x A156, 2x A78, 3x B78

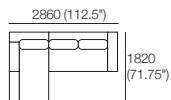

Packages: 13U SLH + 13U SLH SMART

1x S Base 182 S156 RH, 1x S Base 182 S78 LH,
1x A156, 2x A104, 2x A78, 3x B78

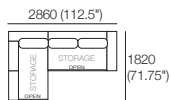

Packages: 13U SRH + 13U SRH SMART

1x S Base 182 S156 LH, 1x S Base 182 S78 RH,
1x A156, 2x A104, 2x A78, 3x B78

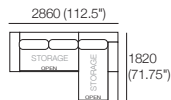

Packages: 1A SLH + 1A SLH SMART

1x S Base 208D S104 LH, 1x S Base 234 S208 RH,
1x A208, 2x A104, 3x B104

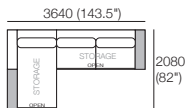

Packages: 9 + 9 SMART

1x P234, 1x P208, 2x C104, 1x C182,
2x A104, 1x A208, 2x B104, 1x B78

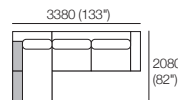

Packages: 9 SLH S234 + 9 SLH S234 SMART

1x S Base 234 S208 RH, 1x P208, 1x C182,
1x A208, 2x A104, 2x B104, 1x B78

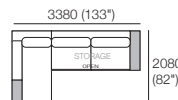

Packages: 9 SRH S234 + 9 SRH S234 SMART

1x S Base 234 C208 LH, 1x P208, 1x C182,
1x A208, 2x A104, 2x B104, 1x B78

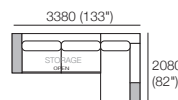

Packages: 1A SRH + 1A SRH SMART

1x S Base 208D S104 RH, 1x S Base 234 S208 LH,
1x A208, 2x A104, 3x B104

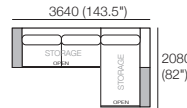

Packages: 7 + 7 SMART

1x P208, 1x P182, 1x P234, 1x C182, 1x C156,
2x C104, 3x A104, 1x A78, 1x A208, 2x B104, 2x B78

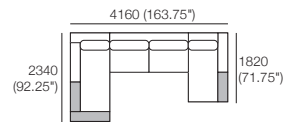

Packages: 7 SLH 182 + 7 SLH 182 SMART

1x S Base 182 S78 LH, 1x P234, 1x P208, 1x C182,
2x C104, 1x A208, 3x A104, 1x A78, 2x B104, 2x B78

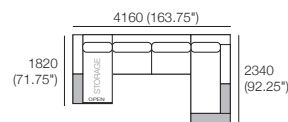

Packages: 7 SRH 182 + 7 SRH 182 SMART

1x S Base 182 S78 RH, 1x P234, 1x P208, 1x C182,
2x C104, 1x A208, 3x A104, 1x A78, 2x B104, 2x B78

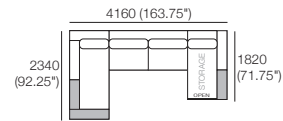

Jasper II Packages 13

KING[®]
L I V I N G



kingliving.com

Jasper II Packages 13

Package: 13

Components: 2x Platform P182, 2x Seat Cushion C156,
1x Arm A104, 1x Arm A156, 1x Arm A78, 3x Back Cushion B78

Shelf Options:

Timber Veneer (STD): 1x T78 + 1x T104

Timber Veneer (Charge): 1x T78 Charge + T104 Charge

Configurations:

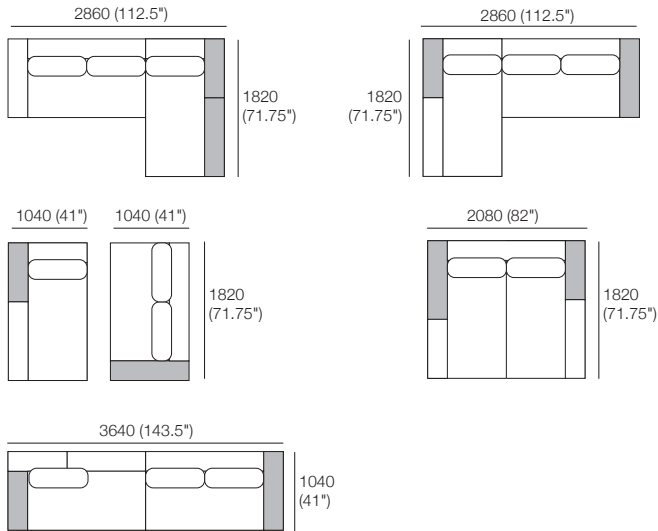

Package: 13 SMART

Components: 2x Platform P182, 2x Seat Cushion C156,
1x Arm A104 SMART, 1x Arm A156 SMART, 1x Arm A78 SMART, 3x Back Cushion B78

Shelf Options:

Timber Veneer (STD): 1x T78 + 1x T104

Timber Veneer (Charge): 1x T78 Charge + T104 Charge

Configurations:

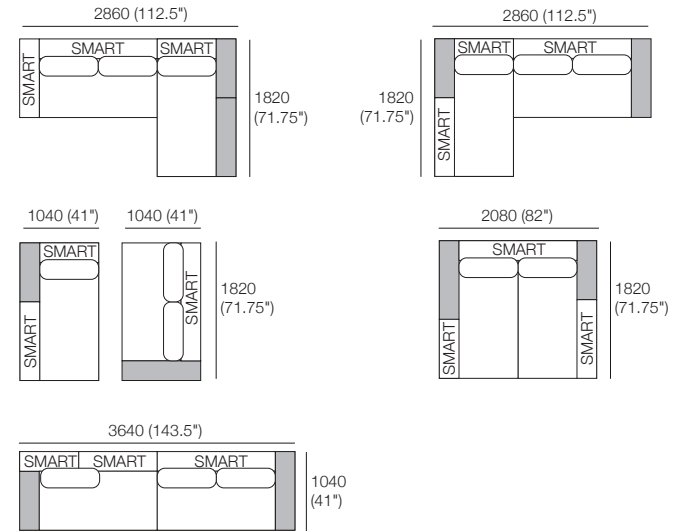

Jasper II Packages 13

Package: 13 SLH

Components: 1x S Base 182 S156 RH, 1x S Base 182 S78 LH,
1x Arm A104, 1x Arm A156, 1x Arm A78, 3x Back Cushion B78

Shelf Options:

Timber Veneer (STD): 1x T78 + 1x T104

Timber Veneer (Charge): 1x T78 Charge + T104 Charge

Configurations:

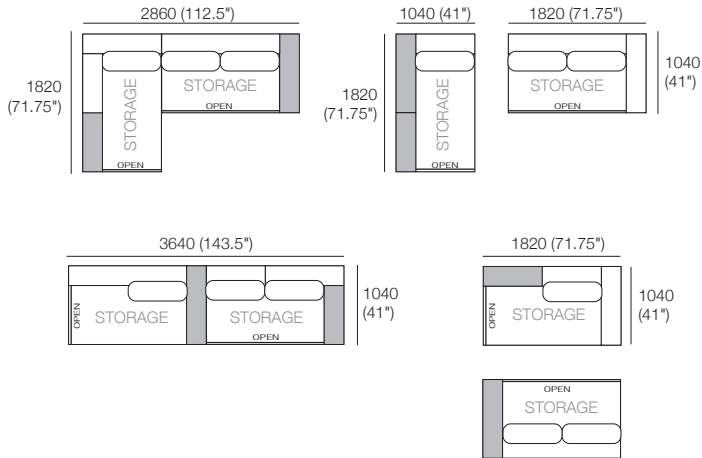

Package: 13 SLH SMART

Components: 1x S Base 182 S156 RH, 1x S Base 182 S78 LH,
1x Arm A104 SMART, 1x Arm A156 SMART, 1x Arm A78 SMART, 3x Back Cushion B78

Shelf Options:

Timber Veneer (STD): 1x T78 + 1x T104

Timber Veneer (Charge): 1x T78 Charge + T104 Charge

Configurations:

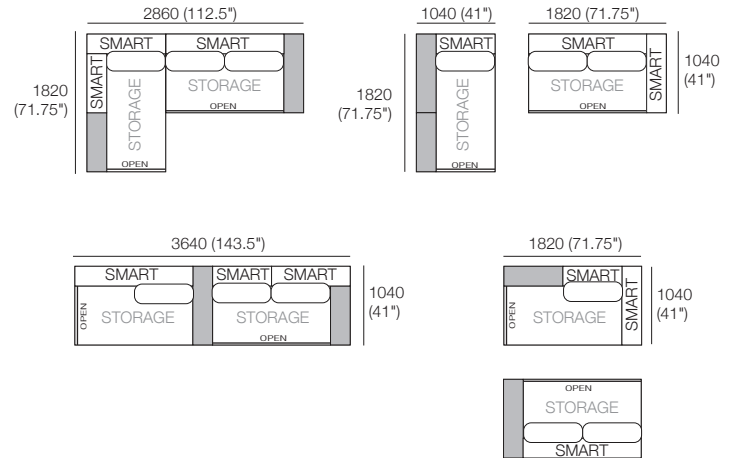

Jasper II Packages 13

Package: 13 SRH

Components: 1x S Base 182 S156 LH, 1x S Base 182 S78 RH,
1x Arm A104, 1x Arm A156, 1x Arm A78, 3x Back Cushion B78

Shelf Options:

Timber Veneer (STD): 1x T78 + 1x T104

Timber Veneer (Charge): 1x T78 Charge + T104 Charge

Configurations:

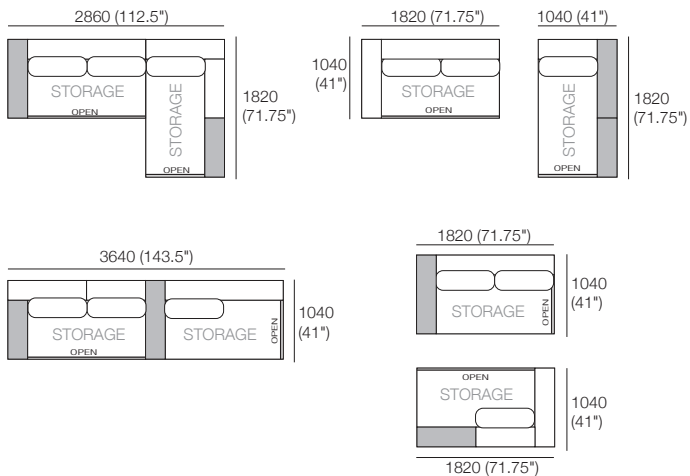

Package: 13 SRH SMART

Components: 1x S Base 182 S156 LH, 1x S Base 182 S78 RH, 1x Arm A104 SMART,
1x Arm A156 SMART, 1x Arm A78 SMART, 3x Back Cushion B78

Shelf Options:

Timber Veneer (STD): 1x T78 + 1x T104

Timber Veneer (Charge): 1x T78 Charge + T104 Charge

Configurations:

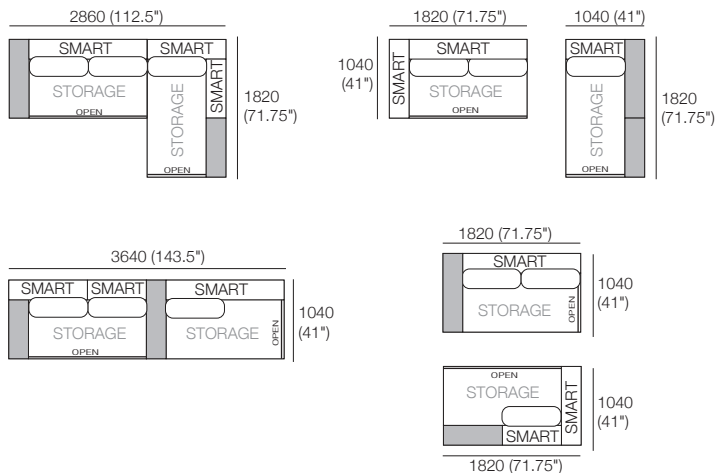

Jasper II Packages 13U

KING[®]
L I V I N G



kingliving.com

Jasper II Packages 13U

Package: 13U

Components: 2x Platform P182, 2x Seat Cushion C156, 2x Arm A104,
1x Arm A156, 2x Arm A78, 3x Back Cushion B78

Configurations:

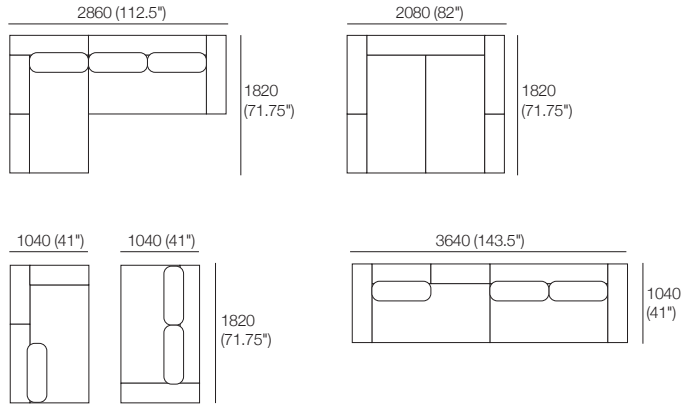

Package: 13U SMART

Components: 2x Platform P182, 2x Seat Cushion C156, 2x Arm A104 SMART,
1x Arm A156 SMART, 2x Arm A78 SMART, 3x Back Cushion B78

Configurations:

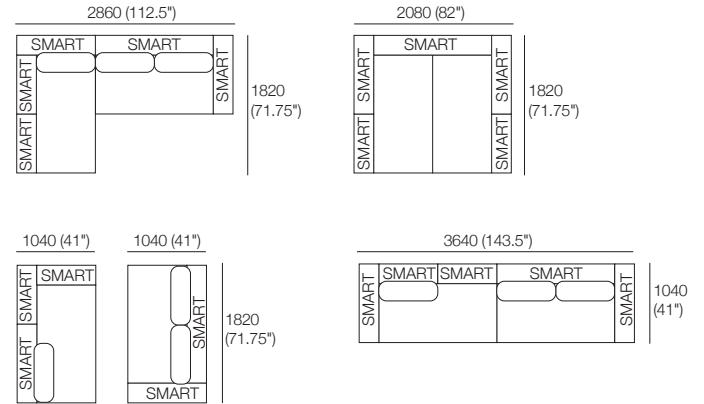

Jasper II Packages 13U

Package: 13U SLH

Components: 1x S Base 182 S156 RH, 1x S Base 182 S78 LH,
1x Arm A156, 2x Arm A104, 2x Arm A78, 3x Back Cushion B78
Configurations:

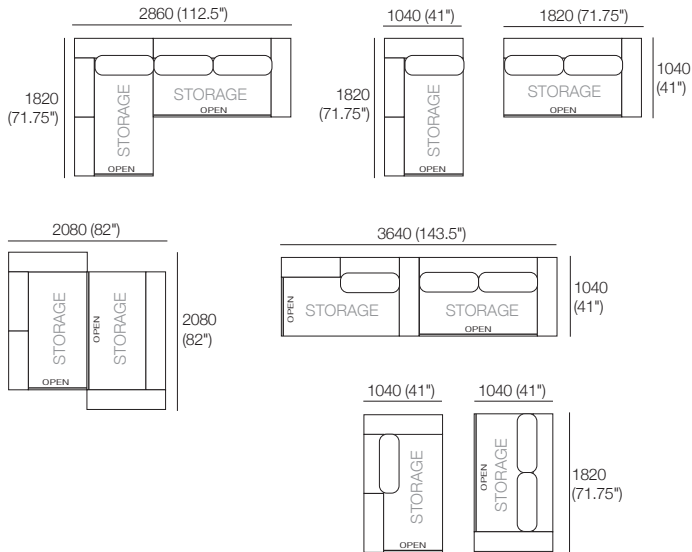

Package: 13U SLH SMART

Components: 1x S Base 182 S156 RH, 1x S Base 182 S78 LH, 1x Arm A156 SMART,
2x Arm A104 SMART, 2x Arm A78 SMART, 3x Back Cushion B78
Configurations:

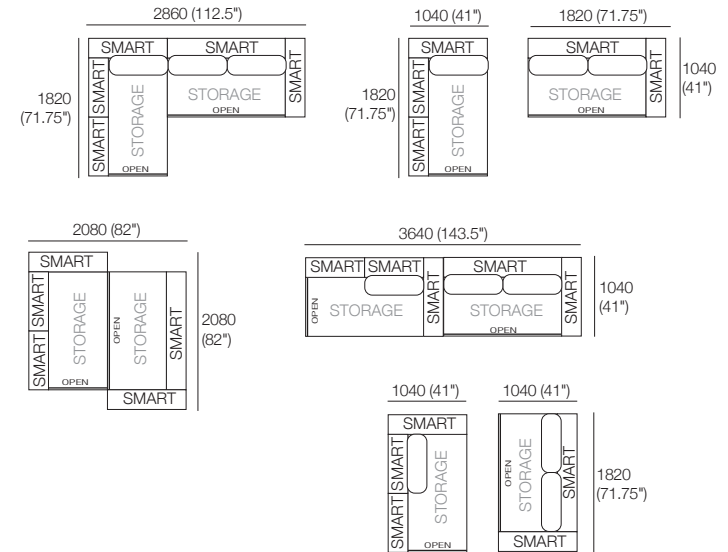

Jasper II Packages 13U

Package: 13U SRH

Components: 1x S Base 182 S156 LH, 1x S Base 182 S78 RH,
1x Arm A156, 2x Arm A104, 2x Arm A78, 3x Back Cushion B78
Configurations:

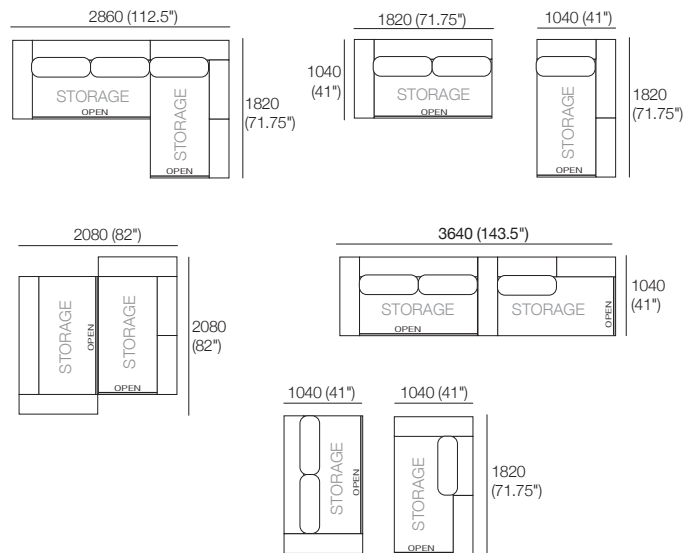

Package: 13U SRH SMART

Components: 1x S Base 182 S156 LH, 1x S Base 182 S78 RH, 1x Arm A156 SMART,
2x Arm A104 SMART, 2x Arm A78 SMART, 3x Back Cushion B78
Configurations:

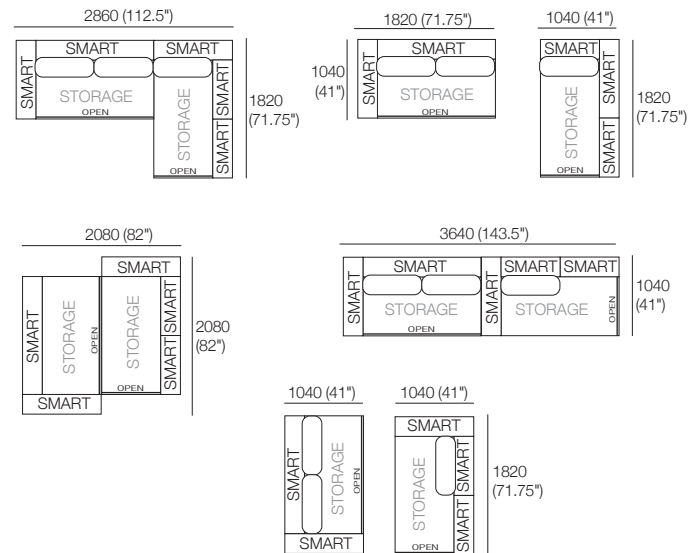

Jasper II Packages 1A

KING[®]
L I V I N G



kingliving.com

Jasper II Packages 1A

Package: 1A

Components: 1x Platform P234, 1x Platform P208D, 2x Seat Cushion C104, 1x Seat Cushion C182D, 1x Arm A208, 2x Arm A104, 3x Back Cushion B104

Shelf Options: Timber Veneer (STD): 2x T104

Timber Veneer (Charge): 2x T104 Charge

Configurations:

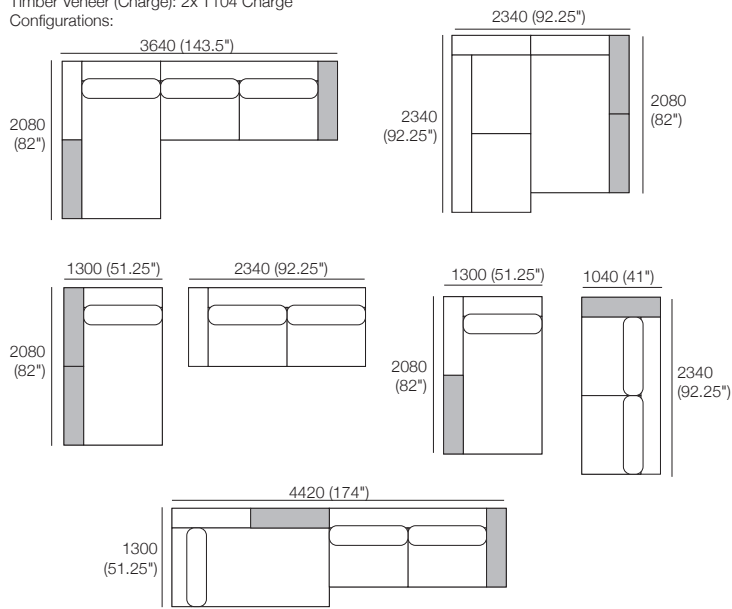

Package: 1A SMART

Components: 1x Platform P234, 1x Platform P208D, 2x Seat Cushion C104, 1x Seat Cushion C182D, 1x Arm A208 SMART, 2x Arm A104 SMART, 3x Back Cushion B104

Shelf Options: Timber Veneer (STD): 2x T104

Timber Veneer (Charge): 2x T104 Charge

Configurations:

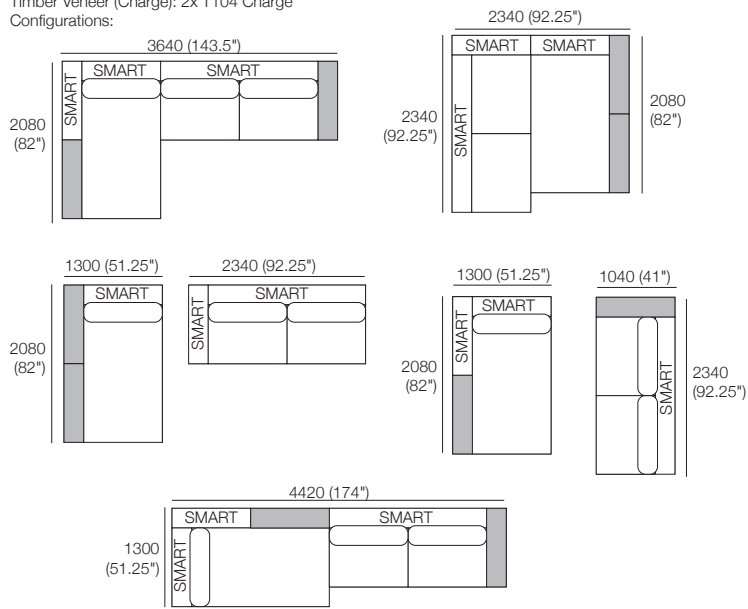

Jasper II Packages 1A

Package: 1A SLH

Components: 1x S Base 208D S104 LH, 1x S Base 234 S208 RH,

1x Arm A208, 2x Arm A104, 3x Back Cushion B104

Shelf Options: Timber Veneer (STD): 2x T104

Timber Veneer (Charge): 2x T104 Charge

Configurations:

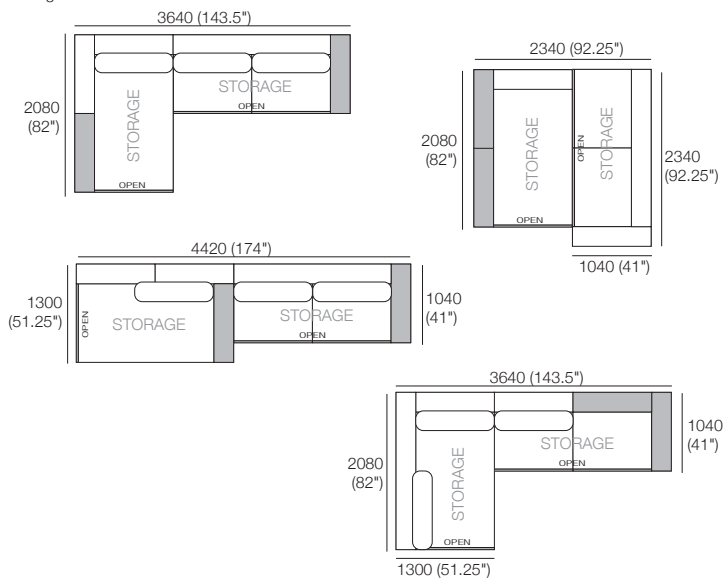

Package: 1A SLH SMART

Components: 1x S Base 208D S104 LH, 1x S Base 234 S208 RH,

1x Arm A208 SMART, 2x Arm A104 SMART, 3x Back Cushion B104

Shelf Options: Timber Veneer (STD): 2x T104

Timber Veneer (Charge): 2x T104 Charge

Configurations:

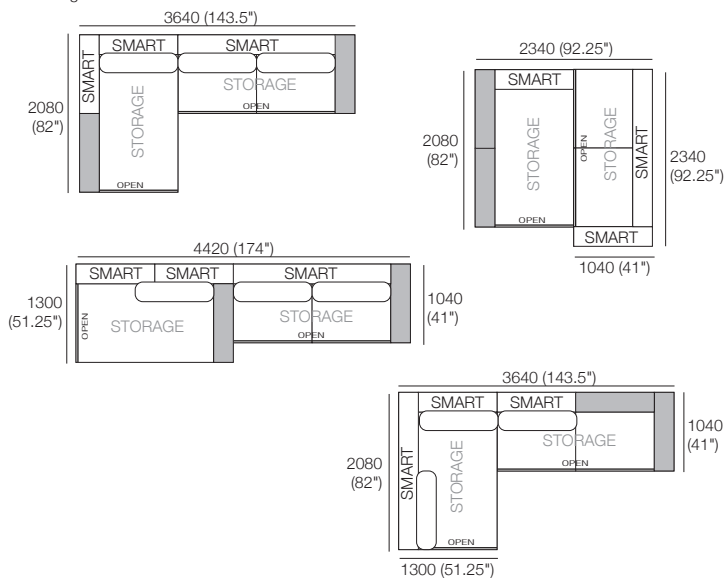

Jasper II Packages 1A

Package: 1A SRH

Components: 1x S Base 208D S104 RH, 1x S Base 234 S208 LH, 1x Arm A208, 2x Arm A104, 3x Back Cushion B104

Shelf Options: Timber Veneer (STD): 2x T104

Timber Veneer (Charge): 2x T104 Charge

Configurations:

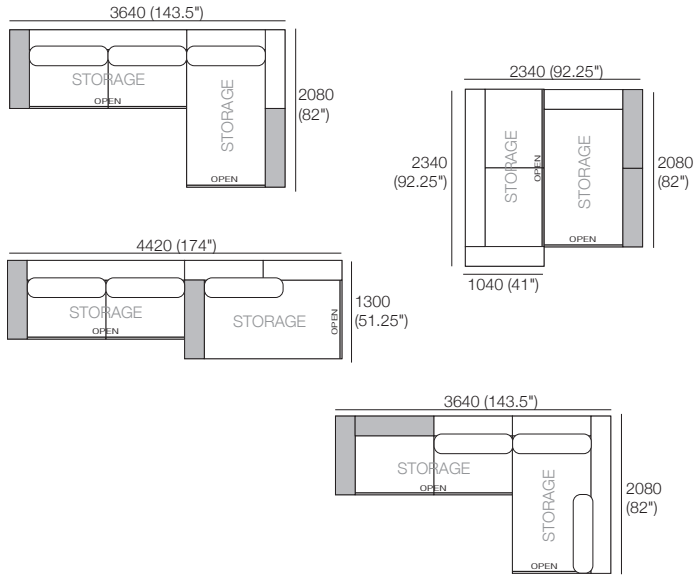

Package: 1A SRH SMART

Components: 1x S Base 208D S104 RH, 1x S Base 234 S208 LH, 1x Arm A208 SMART, 2x Arm A104 SMART, 3x Back Cushion B104

Shelf Options: Timber Veneer (STD): 2x T104

Timber Veneer (Charge): 2x T104 Charge

Configurations:

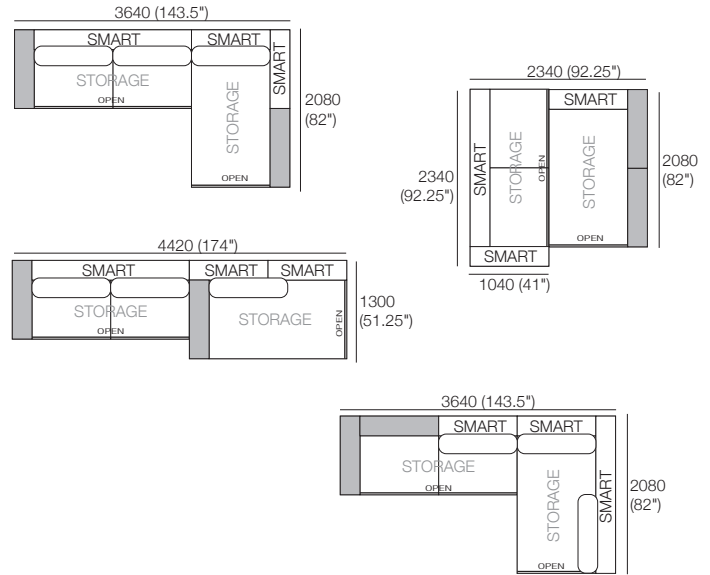

Jasper II Packages 9

KING[®]
L I V I N G



kingliving.com

Jasper II Packages 9

Package: 9

Components: 1x Platform P234, 1x Platform P208, 2x Seat Cushion C104, 1x Seat Cushion C182, 2x Arm A104, 1x Arm A208, 2x Back Cushion B104, 1x Back Cushion B78

Shelf Options:

Timber Veneer (STD): 1x T78 + 1x T104

Timber Veneer (Charge): 1x T78 Charge + T104 Charge

Configurations:

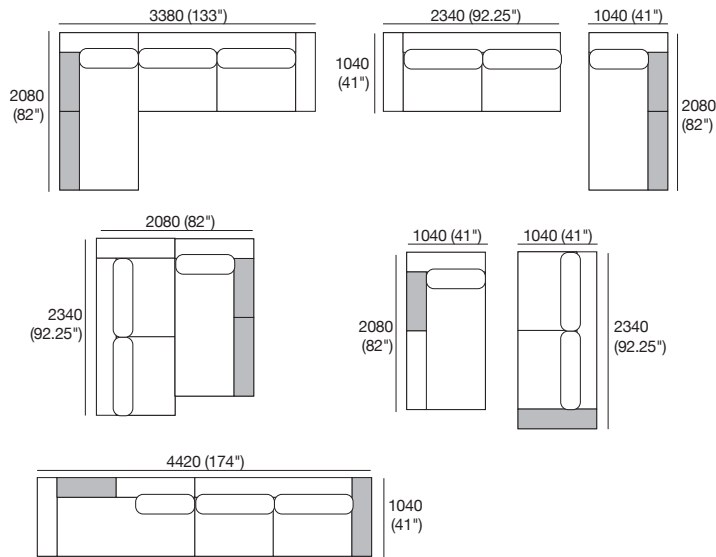

Package: 9 SMART

Components: 1x Platform P234, 1x Platform P208, 2x Seat Cushion C104, 1x Seat Cushion C182, 2x Arm A104 SMART, 1x Arm A208 SMART, 2x Back Cushion B104, 1x Back Cushion B78

Shelf Options:

Timber Veneer (STD): 1x T78 + 1x T104

Timber Veneer (Charge): 1x T78 Charge + T104 Charge

Configurations:

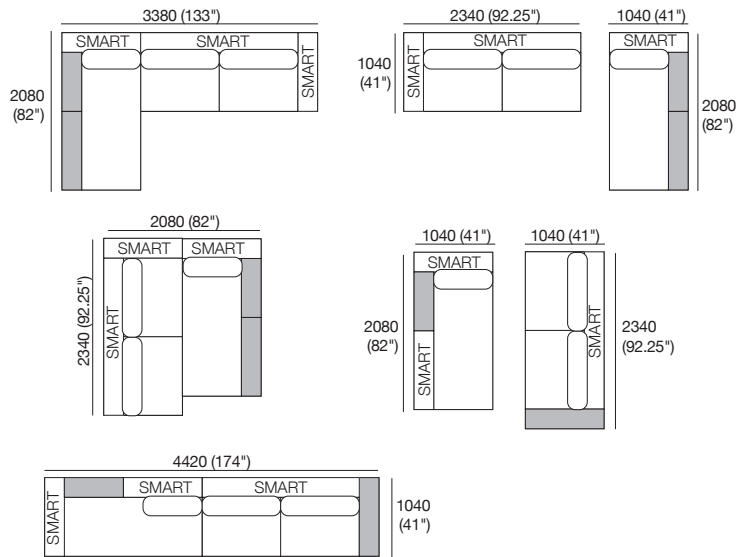

Jasper II Packages 9

Package: 9 SLH S234

Components: 1x S Base 234 S208 RH, 1x Platform P208, 1x Seat Cushion C182,
 1x Arm A208, 2x Arm A104, 2x Back Cushion B104, 1x Back Cushion B78
 Shelf Options: Timber Veneer (STD): 1x T78 + 1x T104
 Timber Veneer (Charge): 1x T78 Charge + T104 Charge
 Configurations:

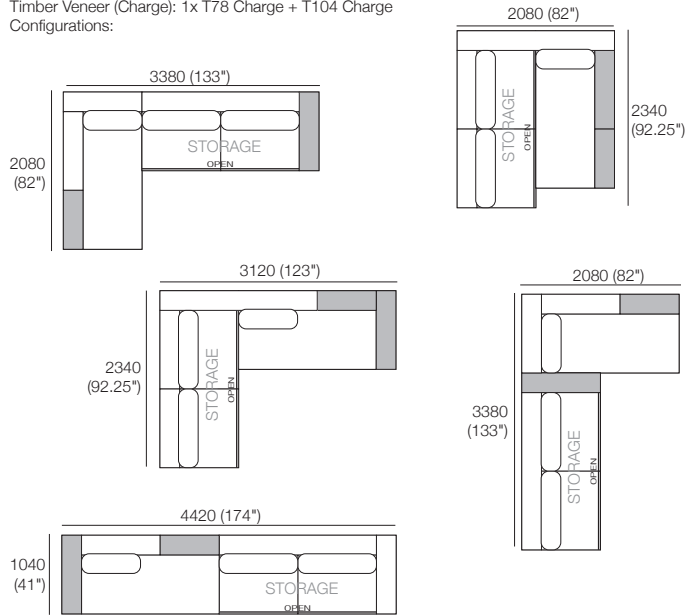

Package: 9 SLH S234 SMART

Components: 1x S Base 234 S208 RH, 1x Platform P208, 1x Seat Cushion C182, 1x Arm A208 SMART,
 2x Arm A104 SMART, 2x Back Cushion B104, 1x Back Cushion B78
 Shelf Options:
 Timber Veneer (STD): 1x T78 + 1x T104
 Timber Veneer (Charge): 1x T78 Charge + T104 Charge
 Configurations:

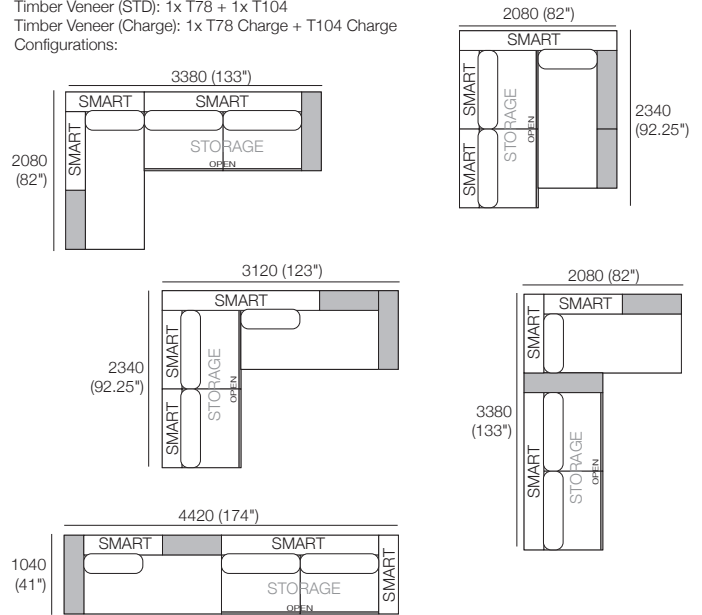

Jasper II Packages 9

Package: 9 SRH S234

Components: 1x S Base 234 C208 LH, 1x Platform P208, 1x Seat Cushion C182,

1x Arm A208, 2x Arm A104, 2x Back Cushion B104, 1x Back Cushion B78

Shelf Options:

Timber Veneer (STD): 1x T78 + 1x T104

Timber Veneer (Charge): 1x T78 Charge + T104 Charge

Configurations:

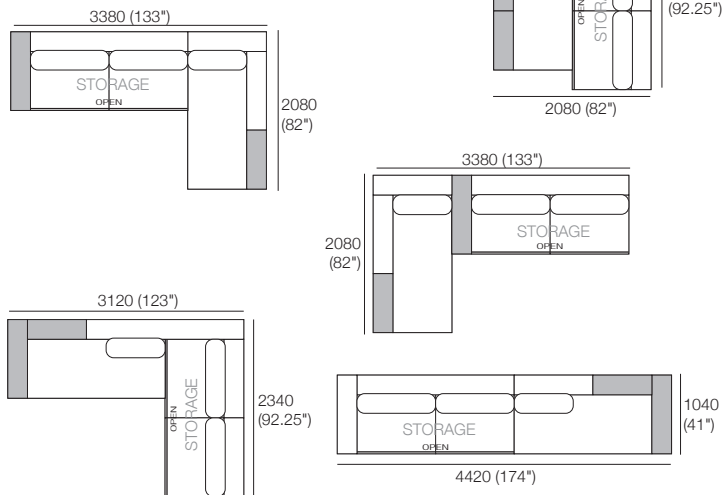

Package: 9 SRH S234 SMART

Components: 1x S Base 234 C208 LH, 1x Platform P208, 1x Seat Cushion C182, 1x Arm A208 SMART,

2x Arm A104 SMART, 2x Back Cushion B104, 1x Back Cushion B78

Shelf Options:

Timber Veneer (STD): 1x T78 + 1x T104

Timber Veneer (Charge): 1x T78 Charge + T104 Charge

Configurations:

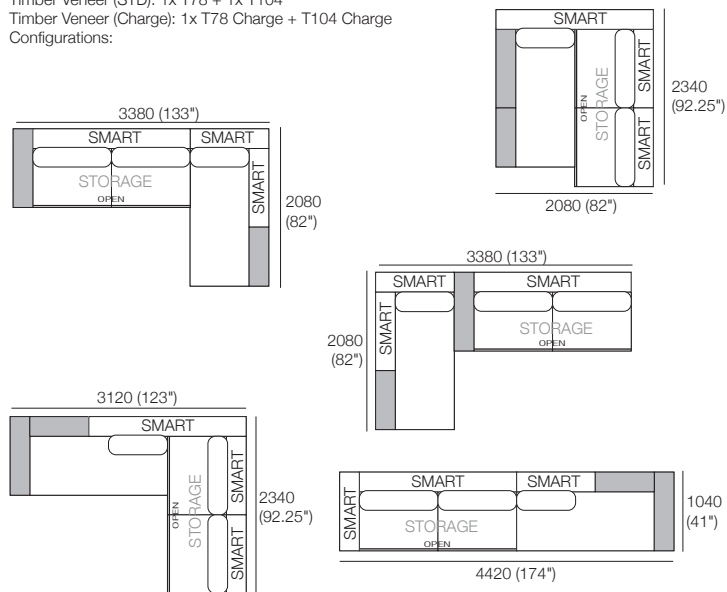

Jasper II Packages 7

KING[®]
L I V I N G



kingliving.com

Jasper II Packages 7

Packages: 7 + 7 SMART (*SMART Arms replace ALL STD Arms)

Components: 1x Platform P208, 1x Platform P182, 1x Platform P234, 1x Seat Cushion C182, 1x Seat Cushion C156, 2x Seat Cushion C104, 3x Arm A104, 1x Arm A78, 1x Arm A208, 2x Back Cushion B104, 2x Back Cushion B78

Shelf Options:

Timber Veneer (STD): 2x T78 + 1x T104

Timber Veneer (Charge): 2x T78 Charge + 1x T104 Charge

Configurations:

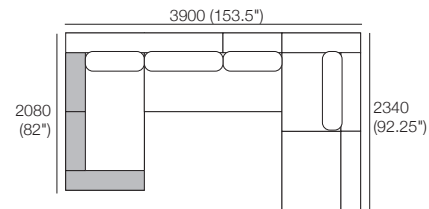
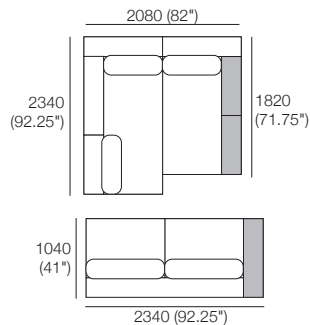
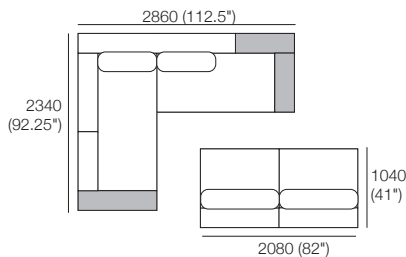
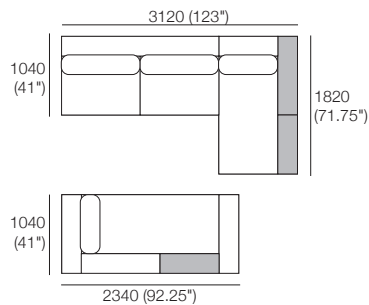
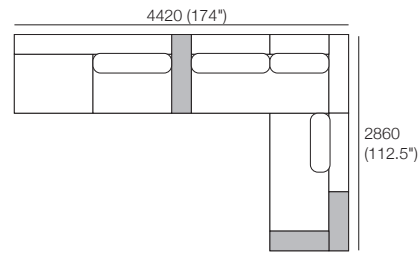
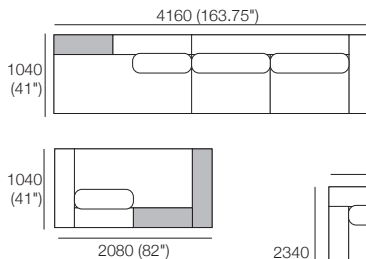
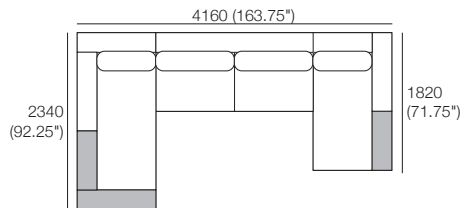

Jasper II Packages 7

Packages: 7 SLH182 + 7 SLH182 SMART (*SMART Arms replace ALL STD Arms)

Components: 1x S Base 182 S78 LH, 1x Platform P234, 1x Platform P208, 1x Seat Cushion C182, 2x Seat Cushion C104,

1x Arm A208, 3x Arm A104, 1x Arm A78, 2x Back Cushion B104, 2x Back Cushion B78

Shelf Options:

Timber Veneer (STD): 2x T78 + 1x T104

Timber Veneer (Charge): 2x T78 Charge + 1x T104 Charge

Configurations:

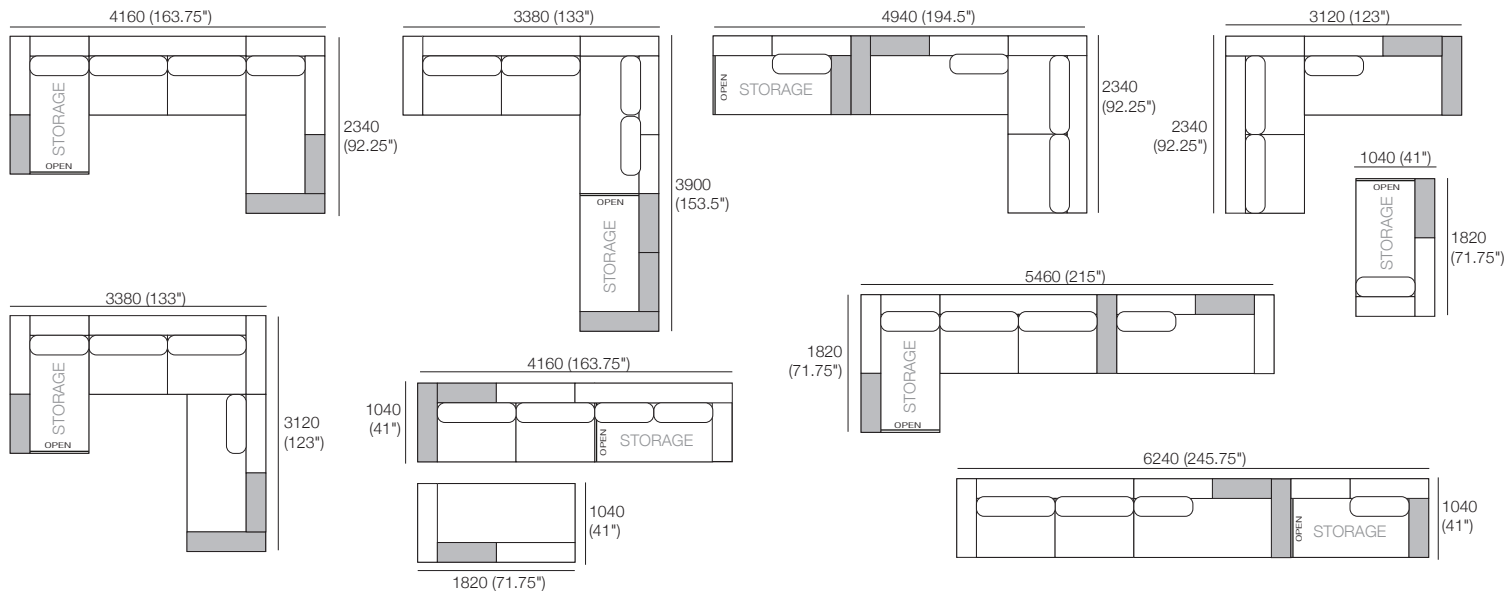

Effective September 2018. Use Magic Joiner M115. *Shelf Options not included in package – price extra. Timber Veneer Shelves available in King Living timber finishes. As King Living has a policy of continuous improvement, changes to products and specifications may be made without prior notice. Images and drawings are representative of design only. Accessories not included.

Jasper II Packages 7

Packages: 7 SRH182 + 7 SRH182 SMART (*SMART Arms replace ALL STD Arms)

Components: 1x S Base 182 S78 RH, 1x Platform P234, 1x Platform P208, 1x Seat Cushion C182, 2x Seat Cushion C104, 1x Arm A208, 3x Arm A104, 1x Arm A78, 2x Back Cushion B104, 2x Back Cushion B78

Shelf Options:

Timber Veneer (STD): 2x T78 + 1x T104

Timber Veneer (Charge): 2x T78 Charge+ 1x T104 Charge

Configurations:

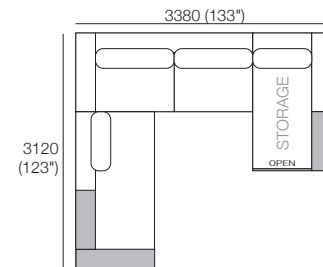
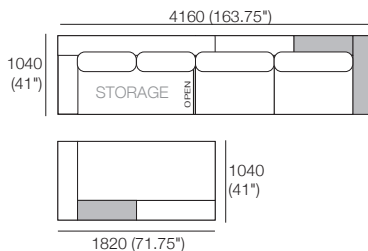
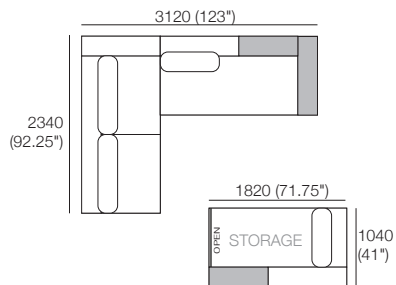
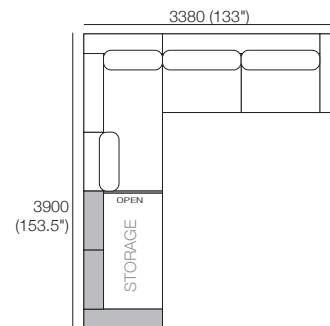
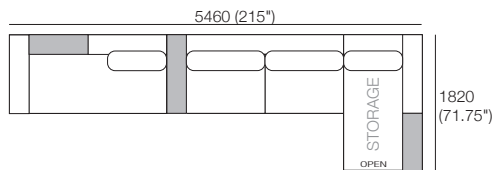
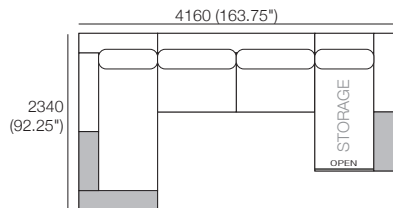

Jasper II Packages

KING[®]
L I V I N G



kingliving.com

Jasper II Packages

Packages: 13B + 13B SMART

2x P182, 2x C156, 1x A156,
1x A104, 1x A78, 4x B78

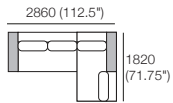

Packages: 13BU + 13B USMART

2x P182, 2x C156, 1x A156,
2x A104, 2x A78, 4x B78

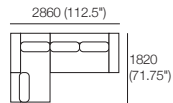

Packages: 1AB

1x P234, 1x P208D, 2x C104, 1x C182D,
1x A208, 2x A104, 4x B104

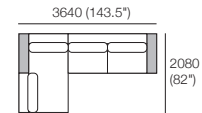

Packages: 13B SLH + 13B SLH SMART

1x S Base 182 S156 RH, 1x S Base 182 S78 LH,
1x A156, 1x A104, 1x A78, 4x B78

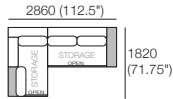

Packages: 13BU SLH + 13BU SLH SMART

1x S Base 182 S156 RH, 1x S Base 182 S78 LH,
1x A156, 2x A104, 2x A78, 4x B78

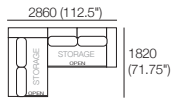

Packages: 1AB SRH

1x S Base 208D S104 RH, 1x S Base 234 S208 LH,
1x A208, 2x A104, 4x B104

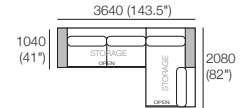

Packages: 13B SRH + 13B SRH SMART

1x S Base 182 S156 LH, 1x S Base 182 S78 RH,
1x A156, 1x A104, 1x A78, 4x B78

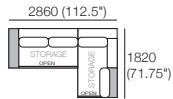

Packages: 13BU SRH + 13BU SRH SMART

1x S Base 182 S156 LH, 1x S Base 182 S78 RH,
1x A156, 2x A104, 2x A78, 4x B78

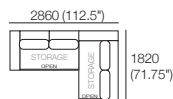

Packages: 1AB SLH

1x S Base 208D S104 LH, 1x S Base 234 S208 RH,
1x A208, 2x A104, 4x B104

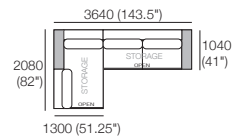

Jasper II Packages 13B

KING[®]
L I V I N G



kingliving.com

Jasper II Packages 13B

Package: 13B

Components: 2x Platform P182, 2x Seat Cushion C156,
1x Arm A156, 1x Arm A104, 1x Arm A78, 4x Back Cushion B78

Shelf Options:

Timber Veneer (STD): 1x T78 + 1x T104

Timber Veneer (Charge): 1x T78 Charge + T104 Charge

Configurations:

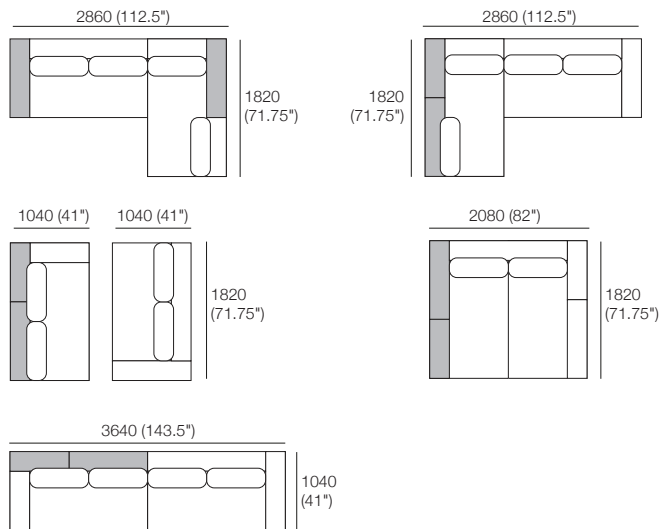

Package: 13B SMART

Components: 2x Platform P182, 2x Seat Cushion C156, 1x Arm A156 SMART,
1x Arm A104 SMART, 1x Arm A78 SMART, 4x Back Cushion B78

Shelf Options:

Timber Veneer (STD): 1x T78 + 1x T104

Timber Veneer (Charge): 1x T78 Charge + T104 Charge

Configurations:

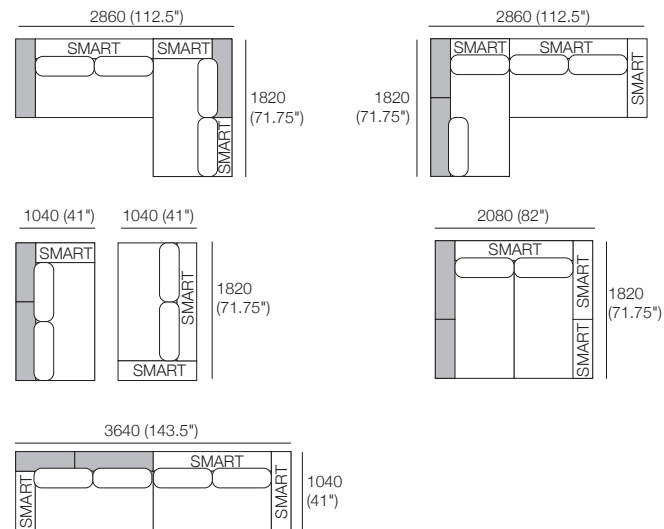

Effective September 2018. Use Magic Joiner M115. *Shelf Options not included in package – price extra. Timber Veneer Shelves available in King Living timber finishes.

As King Living has a policy of continuous improvement, changes to products and specifications may be made without prior notice. Images and drawings are representative of design only. Accessories not included.

Jasper II Packages 13B

Package: 13B SLH

Components: 1x S Base 182 S156 RH, 1x S Base 182 S78 LH,
1x Arm A156, 1x Arm A104, 1x Arm A78, 4x Back Cushion B78

Shelf Options:

Timber Veneer (STD): 1x T78 + 1x T104

Timber Veneer (Charge): 1x T78 Charge + T104 Charge

Configurations:

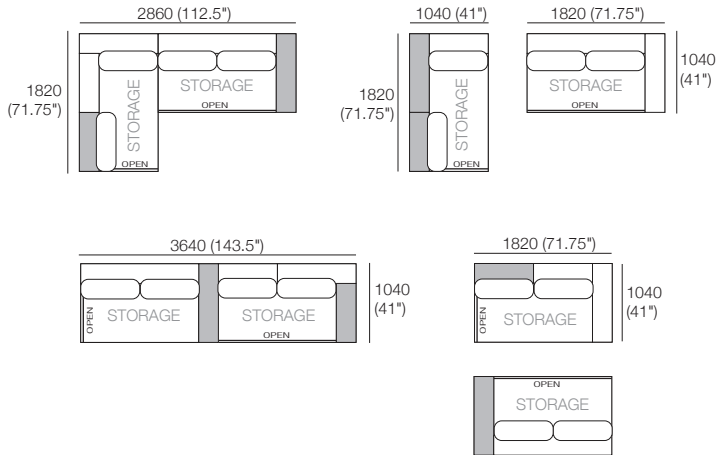

Package: 13B SLH SMART

Components: 1x S Base 182 S156 RH, 1x S Base 182 S78 LH,
1x Arm A156 SMART, 1x Arm A104 SMART, 1x Arm A78 SMART, 4x Back Cushion B78

Shelf Options:

Timber Veneer (STD): 1x T78 + 1x T104

Timber Veneer (Charge): 1x T78 Charge + T104 Charge

Configurations:

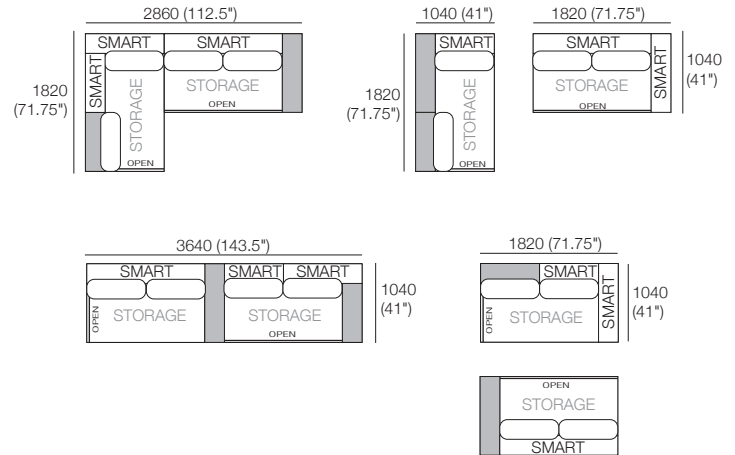

Effective September 2018. Use Magic Joiner M115. *Shelf Options not included in package – price extra. Timber Veneer Shelves available in King Living timber finishes.

As King Living has a policy of continuous improvement, changes to products and specifications may be made without prior notice. Images and drawings are representative of design only. Accessories not included.

Jasper II Packages 13B

Package: 13B SRH

Components: 1x S Base 182 S156 LH, 1x S Base 182 S78 RH, 1x Arm A156, 1x Arm A104, 1x Arm A78, 4x Back Cushion B78

Shelf Options:

Timber Veneer (STD): 1x T78 + 1x T104

Timber Veneer (Charge): 1x T78 Charge + T104 Charge

Configurations:

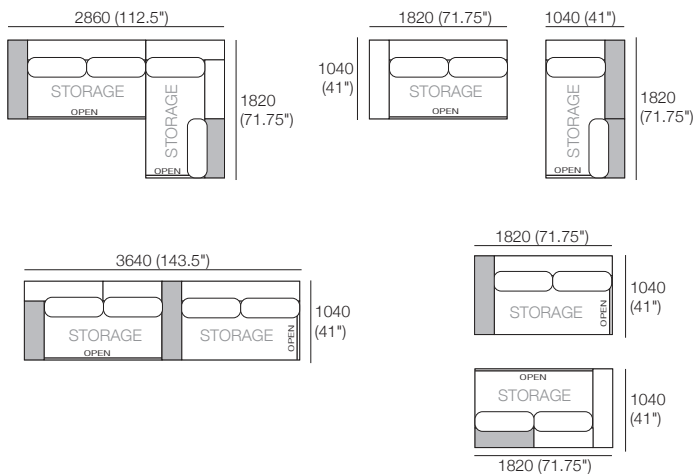

Package: 13B SRH SMART

Components: 1x S Base 182 S156 LH, 1x S Base 182 S78 RH, 1x Arm A156 SMART, 1x Arm A104 SMART, 1x Arm A78 SMART, 4x Back Cushion B78

Shelf Options:

Timber Veneer (STD): 1x T78 + 1x T104

Timber Veneer (Charge): 1x T78 Charge + T104 Charge

Configurations:

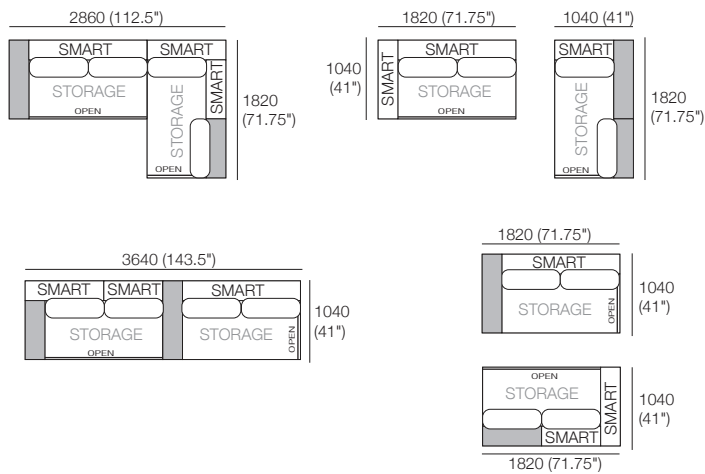

Jasper II Packages 13BU

KING[®]
L I V I N G



kingliving.com

Jasper II Packages 13BU

Package: 13BU

Components: 2x Platform P182, 2x Seat Cushion C156, 1x Arm A156,
2x Arm A104, 2x Arm A78, 4x Back Cushion B78

Configurations:

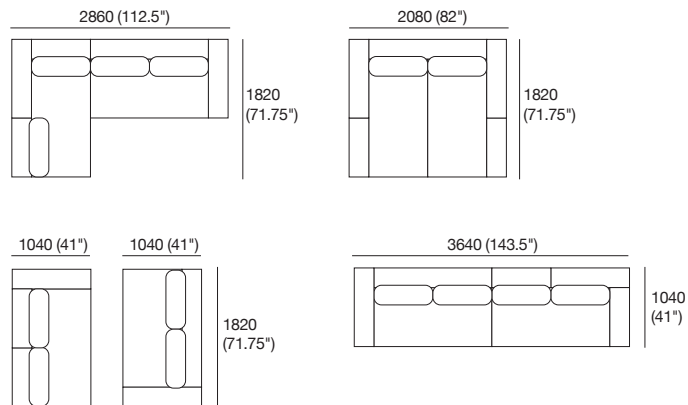

Package: 13BU SMART

Components: 2x Platform P182, 2x Seat Cushion C156, 1x Arm A156 SMART,
2x Arm A104 SMART, 2x Arm A78 SMART, 4x Back Cushion B78

Configurations:

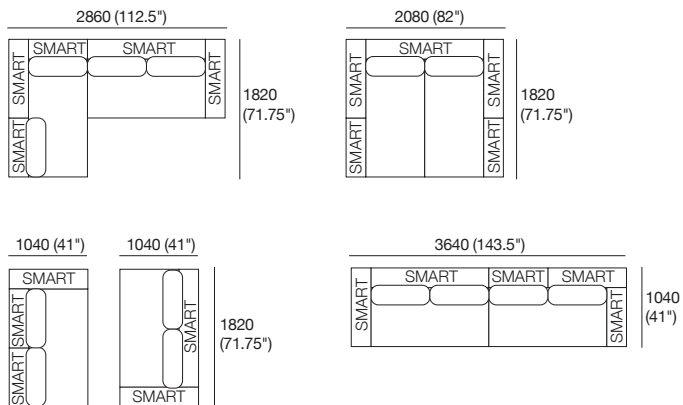

Jasper II Packages 13BU

Package: 13BU SLH

Components: 1x S Base 182 S156 RH, 1x S Base 182 S78 LH,
1x Arm A156, 2x Arm A104, 2x Arm A78, 4x Back Cushion B78
Configurations:

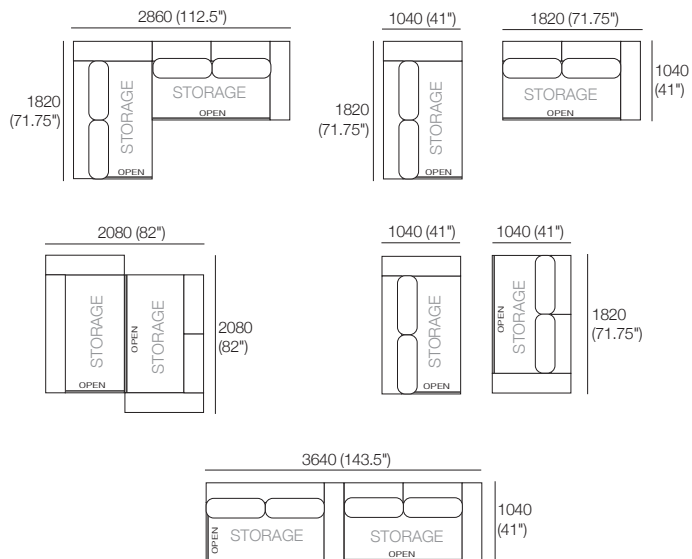

Package: 13BU SLH SMART

Components: 1x S Base 182 S156 RH, 1x S Base 182 S78 LH, 1x Arm A156 SMART,
2x Arm A104 SMART, 2x Arm A78 SMART, 4x Back Cushion B78
Configurations:

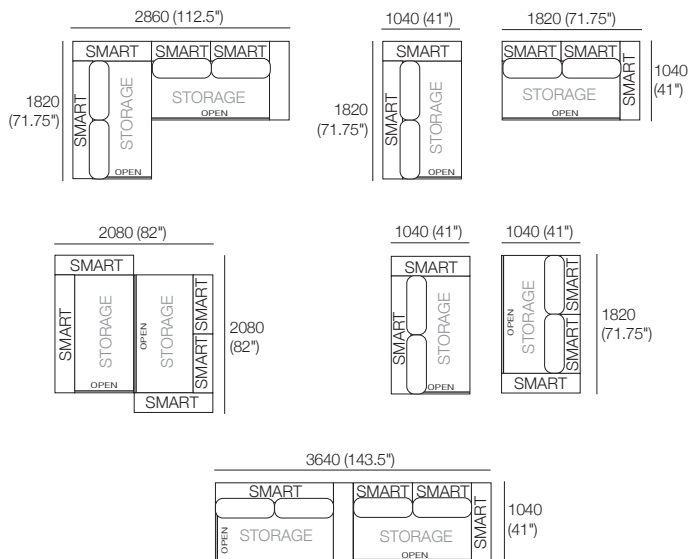

Jasper II Packages 13BU

Package: 13BU SRH

Components: 1x S Base 182 S156 LH, 1x S Base 182 S78 RH,
1x Arm A156, 2x Arm A104, 2x Arm A78, 4x Back Cushion B78
Configurations:

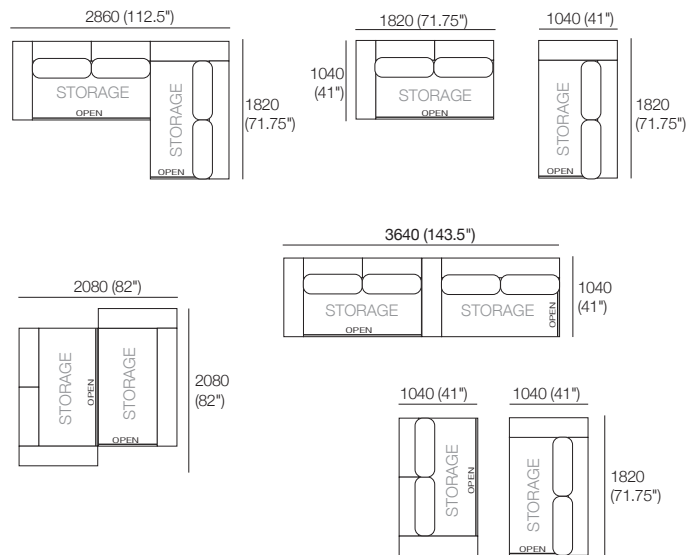

Package: 13BU SRH SMART

Components: 1x S Base 182 S156 LH, 1x S Base 182 S78 RH, 1x Arm A156 SMART,
2x Arm A104 SMART, 2x Arm A78 SMART, 4x Back Cushion B78
Configurations:

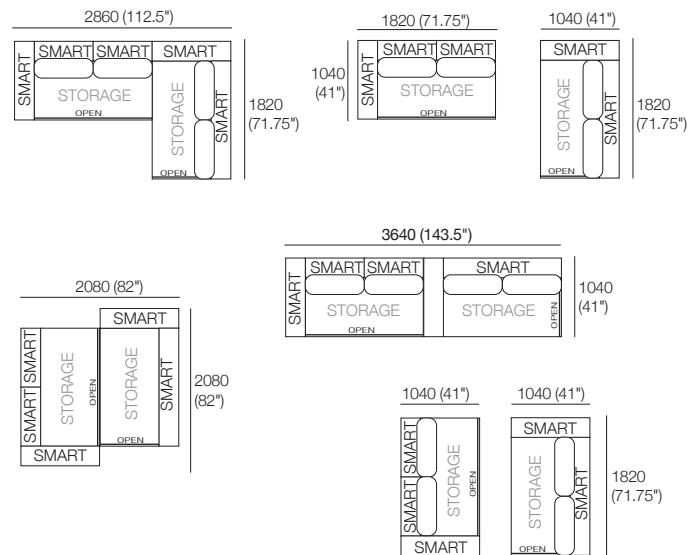

Jasper II Packages 1AB

KING[®]
L I V I N G



kingliving.com

Jasper II Packages 1AB

Package: 1AB

Components: 1x Platform P234, 1x Platform P208D, 2x Seat Cushion C104, 1x Seat Cushion C182D, 1x Arm A208, 2x Arm A104, 4x Back Cushion B104

Shelf Options: Timber Veneer (STD): 2x T104

Timber Veneer (Charge): 2x T104 Charge

Configurations:

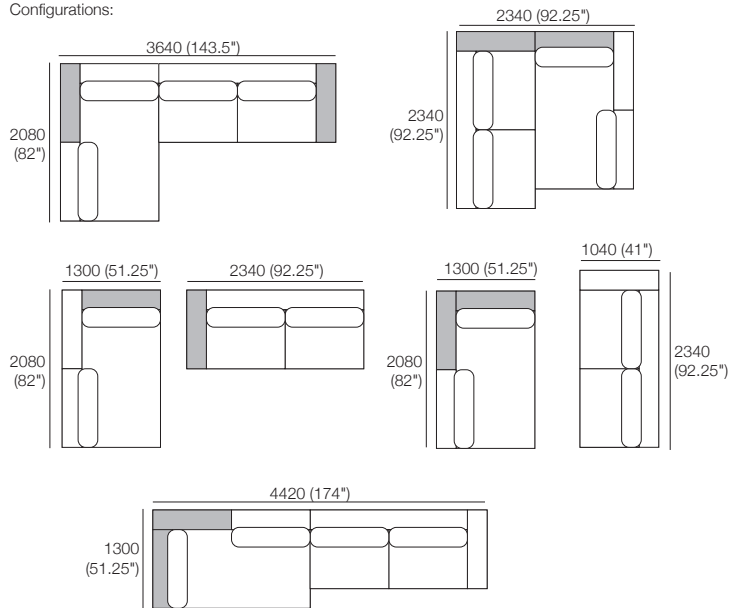

Package: 1AB SMART

Components: 1x Platform P234, 1x Platform P208D, 2x Seat Cushion C104,

1x Seat Cushion C182D, 1x Arm A208 SMART, 2x Arm A104 SMART, 4x Back Cushion B104

Shelf Options: Timber Veneer (STD): 2x T104

Timber Veneer (Charge): 2x T104 Charge

Configurations:

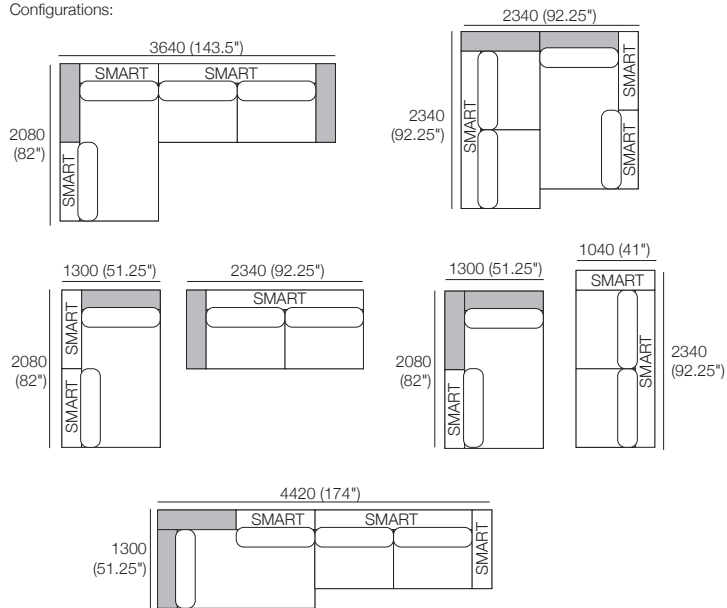

Jasper II Packages 1AB

Package: 1AB SLH

Components: 1x S Base 208D S104 LH, 1x S Base 234 S208 RH,
 1x Arm A208, 2x Arm A104, 4x Back Cushion B104
 Shelf Options: Timber Veneer (STD): 2x T104
 Timber Veneer (Charge): 2x T104 Charge
 Configurations:

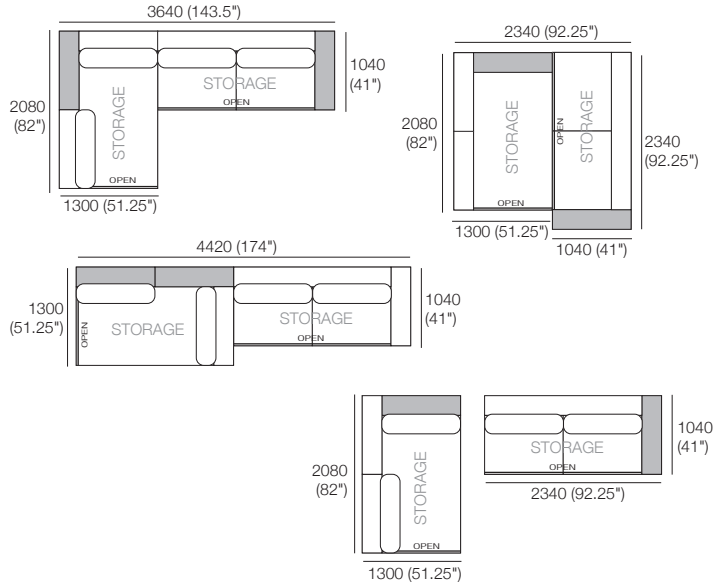

Package: 1AB SLH SMART

Components: 1x S Base 208D S104 LH, 1x S Base 234 S208 RH,
 1x Arm A208 SMART, 2x Arm A104 SMART, 4x Back Cushion B104
 Shelf Options: Timber Veneer (STD): 2x T104
 Timber Veneer (Charge): 2x T104 Charge
 Configurations:

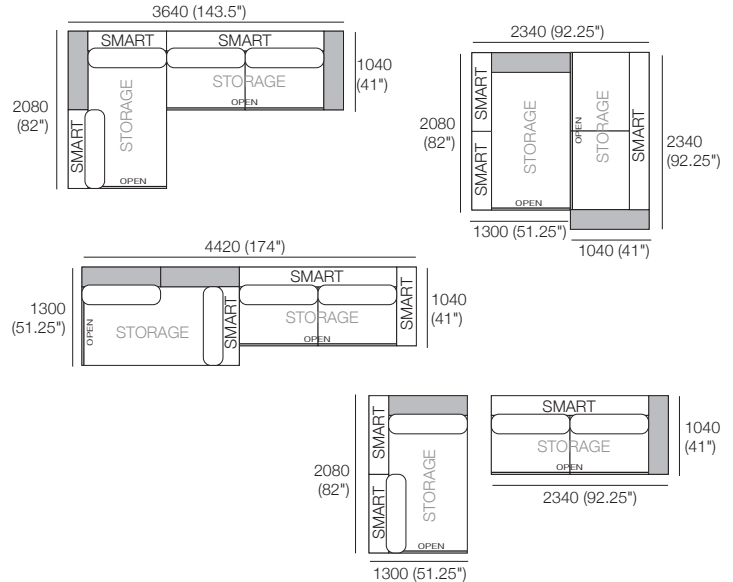

Jasper II Packages 1AB

Package: 1AB SRH

Components: 1x S Base 208D S104 RH, 1x S Base 234 S208 LH, 1x Arm A208, 2x Arm A104, 4x Back Cushion B104

Shelf Options: Timber Veneer (STD): 2x T104

Timber Veneer (Charge): 2x T104 Charge

Configurations:

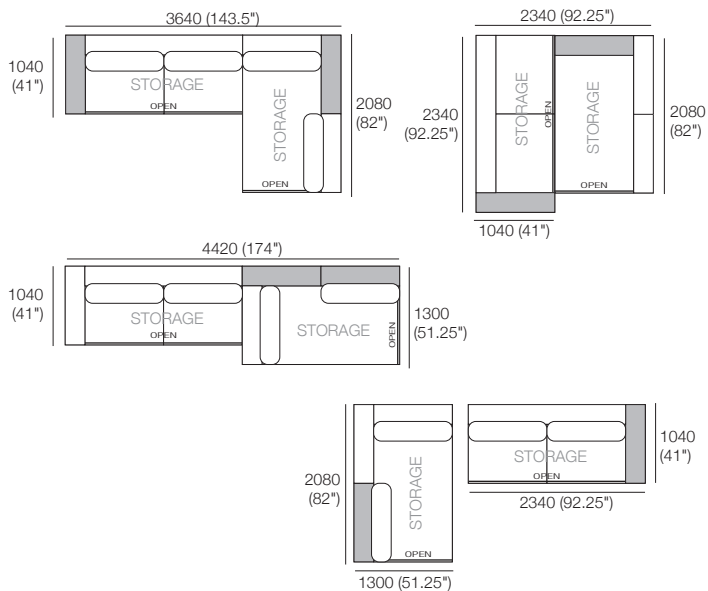

Package: 1AB SRH SMART

Components: 1x S Base 208D S104 RH, 1x S Base 234 S208 LH, 1x Arm A208 SMART, 2x Arm A104 SMART, 4x Back Cushion B104

Shelf Options: Timber Veneer (STD): 2x T104

Timber Veneer (Charge): 2x T104 Charge

Configurations:

