

Jasper

We
see
possible

KING[®]
L I V I N G



kingliving.com

Jasper Components

Platforms

1040(D) 240(H)

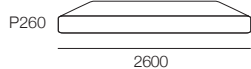
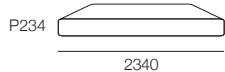
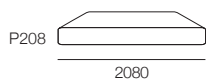
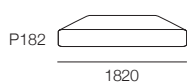
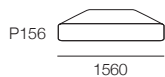
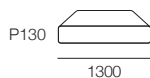
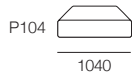

Platforms

1300(D) 240(H)

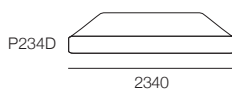
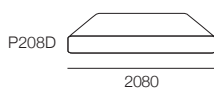
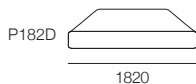
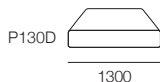
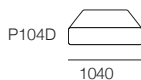

Arms/Backs Upholstered

260(D) 310(H)

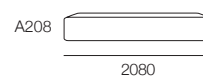
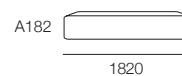
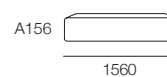
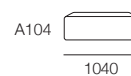

Jasper Components

Seat Cushions

780(D) 200(H)

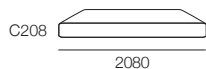
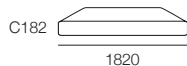
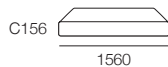
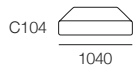
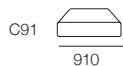
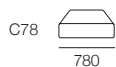

Seat Cushions

1040(D) 200(H)

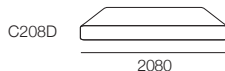
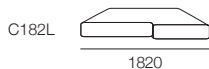
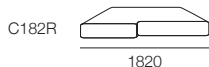
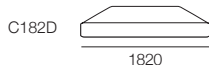
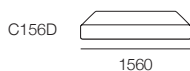

Back Cushions

500(H)

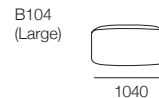
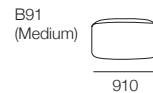
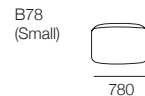

Timber Veneer Shelves

260(W) 310(H)

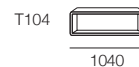
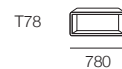

Jasper Bed Brackets



Jasper Sets



Chair 78

1x P78, 1x C78
1x A78, 1x B78



2 Seater

1x P208, 2x C78,
1x A156, 2x A104,
2x B78



2 Seater Plus

1x P208D, 2x C104,
1x A208, 2x T104,
2x B104



Chair 104

1x P104, 1x C104
1x A104, 1x B104



2 Seater Deep

1x P208D, 2x C104,
4x A104, 2x B78

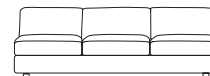

3 Seater No Arms

1x P234, 3x C78,
3x A78, 3x B78



Chair 104T

1x P104, 1x C78
1x A78, 1x B78
1x T104



2 Seater No Arms

1x P208, 2x C104,
1x A208, 2x B104



3 Seater Deep No Arms

1x P234D, 3x C104,
3x A78, 3x B78



Chair 130

1x P130, 1x C104
2x A104, 1x B104



2 Seater Deep Plus

1x P208D, 2x C104,
1x A208, 2x T104,
2x B78

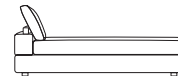

Chaise

1x P208, 1x C182D,
1x A104, 1x B104



Chair 130T

1x P130, 1x C104
1x A104, 1x B104
1x T104



2 Seater End

1x P182, 2x C78,
1x A156, 1x A104,
2x B78

Arm can be placed
on either side.

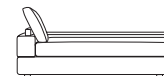

2 Seater Chaise

1x P182, 1x C156,
1x A156, 1x A104,
1x B78

Arm can be placed
on either side.



Chair End 130T

1x P130, 1x C104,
2x T104

Jasper Package 1AP

Package 1AP Configurations:

Components: 1x P234, 1x P208D, 2x C104, 1x C182D, 3x B104, 2x A104, 1x A208,

Timber Shelves: 2x T104

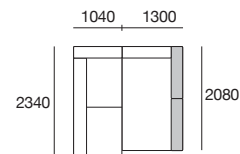
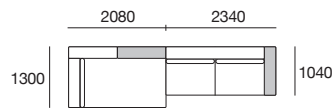
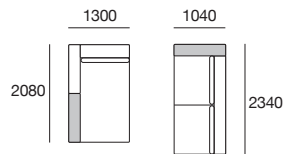
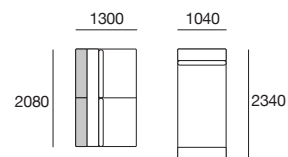
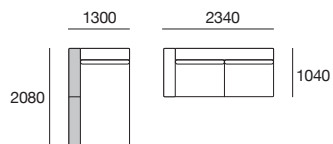
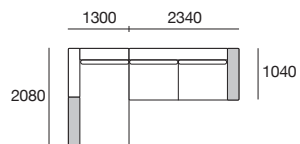

Jasper Package 7

Package 7 Configurations:

Components: 1x P234, 1x P208, 1x P182, 1x C182, 1x C156, 2x C104, 1x A208, 1x A78, 3x A104, 2x B104, 2x B78,

Timber Shelves: 2x T78, 1x T104

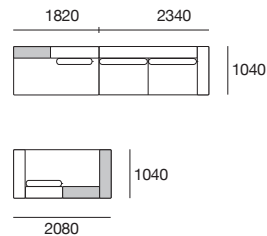
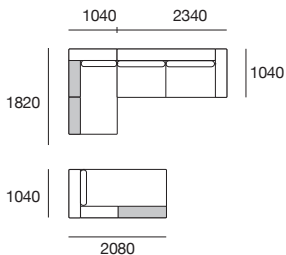
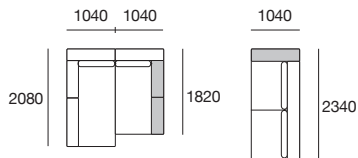
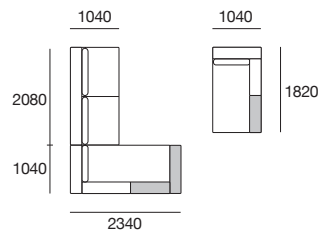
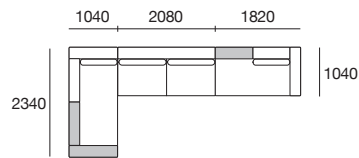
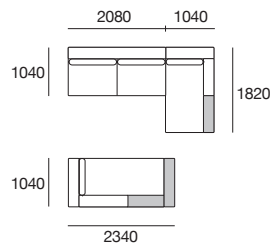
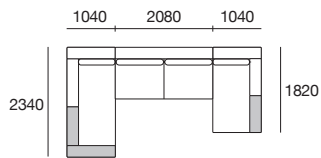

Jasper Package 9

Package 9 Configurations:

Components: 1x P234, 1x P208, 2x C104, 1x C182, 2x B104, 1x B78, 2x A104, 1x A208,

Timber Shelves: 1x T104, 1x T78

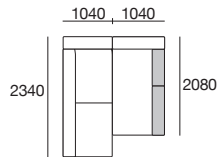
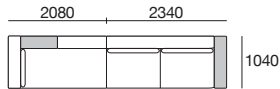
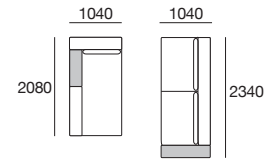
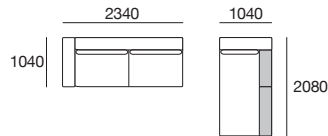
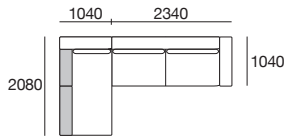

Jasper Package 13P

Package 13P Configurations:

Components: 2x P182, 2x C156, 3x B78, 1x A156, 1x A104, 1x A78, **Timber Shelves:** 1x T104, 1x T78

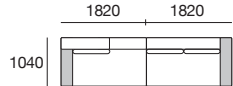
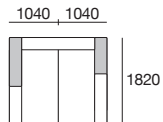
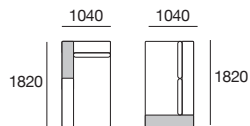
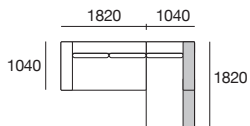
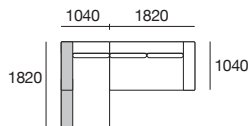

Jasper Package 13U

Package 13U Configurations:

Components: 2x P182, 2x C156, 3x B78, 1x A156, 2x A104, 2x A78

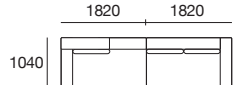
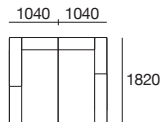
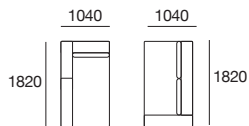
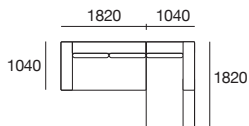
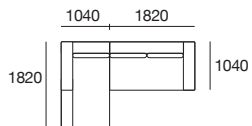

Jasper Occasional Tables & Cube Ottoman

KING[®]
L I V I N G



kingliving.com

Jasper Occasional Tables & Cube Ottoman

Timber Table 260xD780
345-360mm (H)

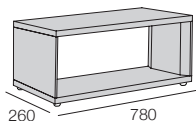

Jasper Cube Ottoman
345-360mm (H)
Leather Stitching Detail

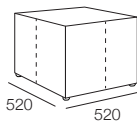

Glass Table 520xD780
345-360mm (H)

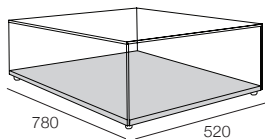

STD Legs
Adjustable to 15

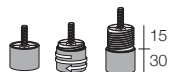

Glass Table 780xD780
345-360mm (H)

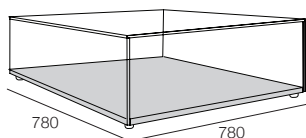

Packages: Configurations

TIMB-GLASS 1040x780

Components: 2x Timber Table T260xD780, 1x Glass Table T520xD780

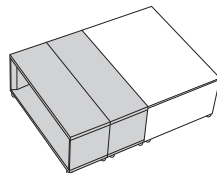

Top View

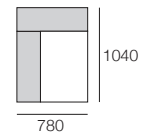
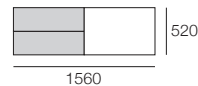
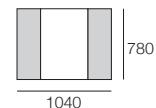
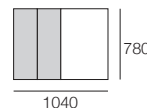

TIMB-GLASS 1300x780

Components: 2x Timber Table T260xD780, 1x Glass Table T780xD780

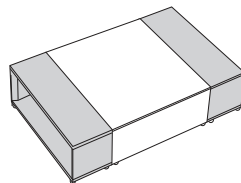

Top View

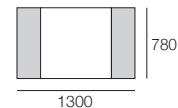
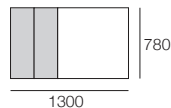

Jasper Occasional Table

Assembly Instructions

KING[®]
L I V I N G

Two people are required for safe assembly.

Opening Boxes

DO NOT use a knife to open the King Living boxes as you may damage your furniture.

Peel off the tape, then lift & separate the cardboard flaps to open.

Assemble your furniture by following the steps below.

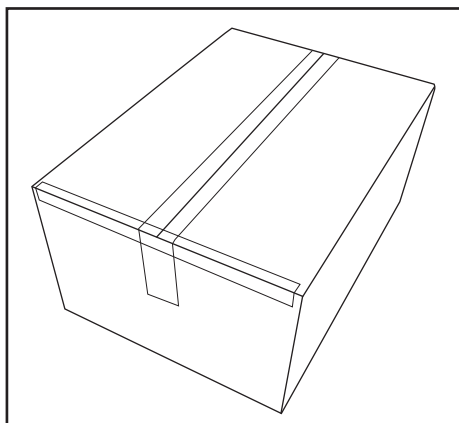

1

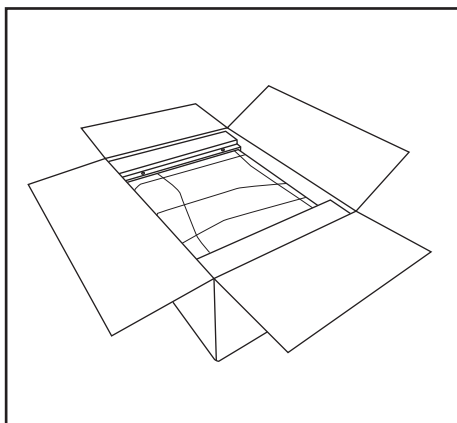

2

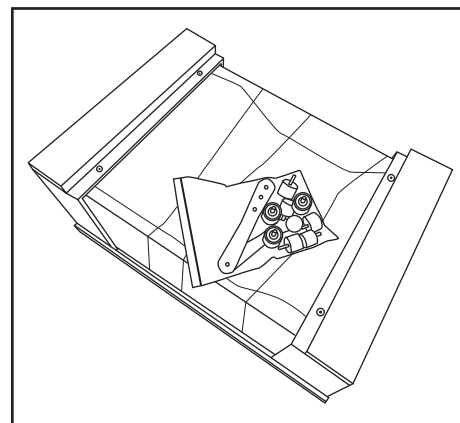

3

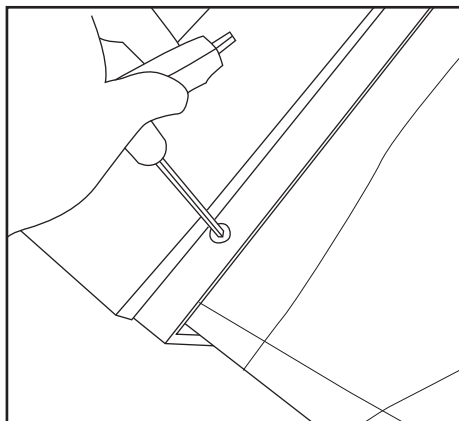

4

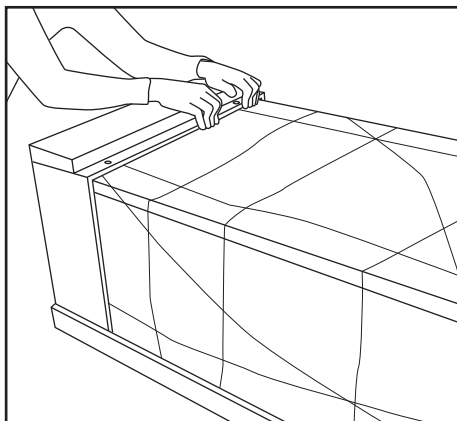

5

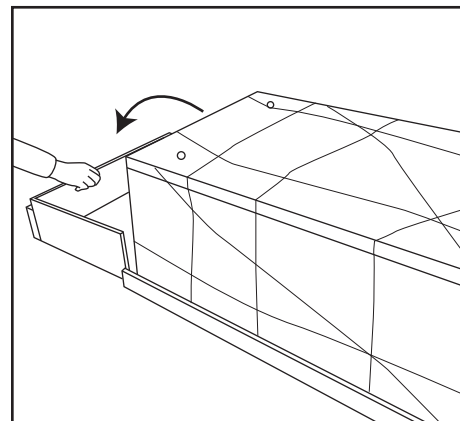

6

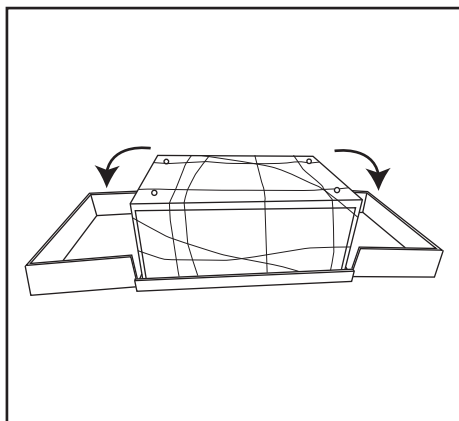

7

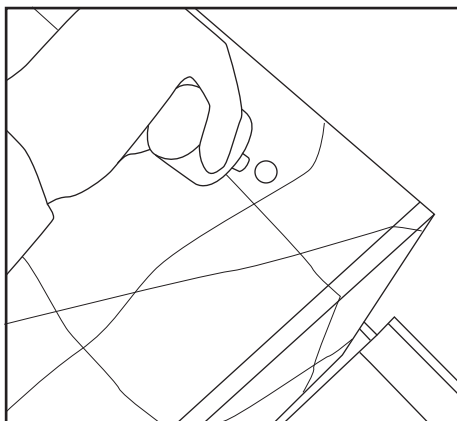

8

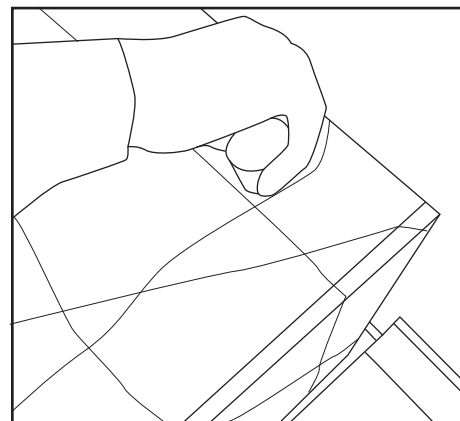

9

KING LIVING
CUSTOMER CARE:

AUSTRALIA:

T 1300 135 464

E service@kingliving.com.au

W kingliving.com.au

NEW ZEALAND:

T 0800 546 422

E service@kingliving.co.nz

W kingliving.co.nz

SINGAPORE:

T +65 6805 4198

E kingcare@kingliving.com.sg

W kingliving.com.sg

MALAYSIA:

T +603 7732 0272

E service@kingliving.my

W kingliving.my

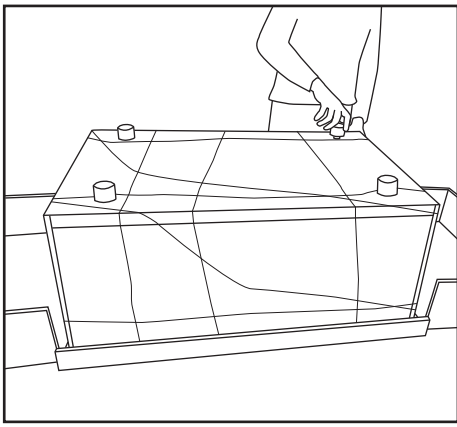

10

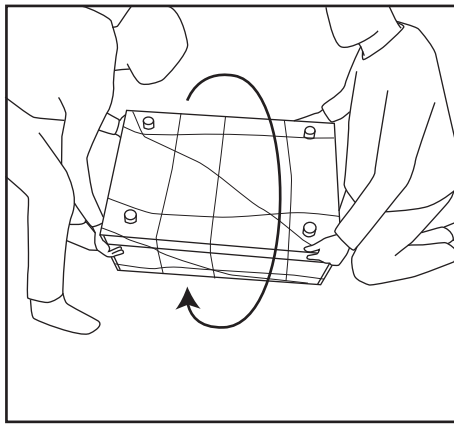

11

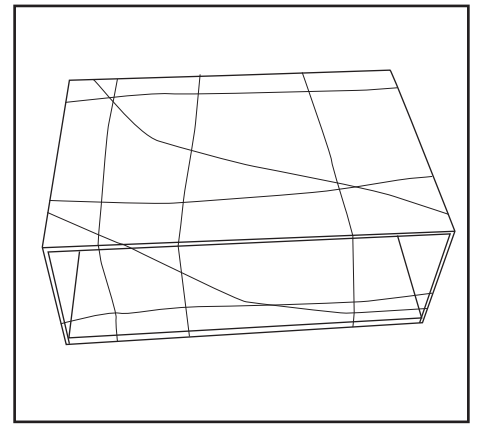

12

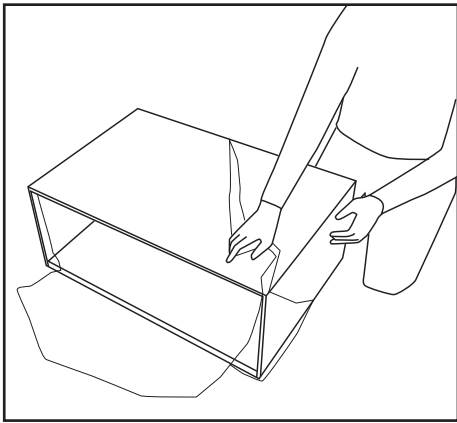

13

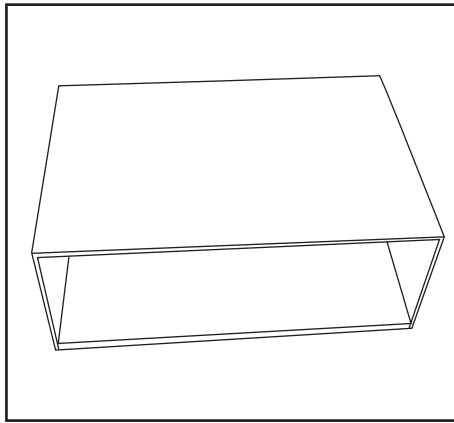

14

**KING LIVING
CUSTOMER CARE:**

AUSTRALIA:
T 1300 135 464
E service@kingliving.com.au
W kingliving.com.au

NEW ZEALAND:
T 0800 546 422
E service@kingliving.co.nz
W kingliving.co.nz

SINGAPORE:
T +65 6805 4198
E kingcare@kingliving.com.sg
W kingliving.com.sg

MALAYSIA:
T +603 7732 0272
E service@kingliving.my
W kingliving.my